

YAMAHA

DSP-A3090

DIGITAL SOUND FIELD PROCESSING AMPLIFIER

AMPLIFICATEUR DE TRAITEMENT DE CHAMP SONORE NUMERIQUE

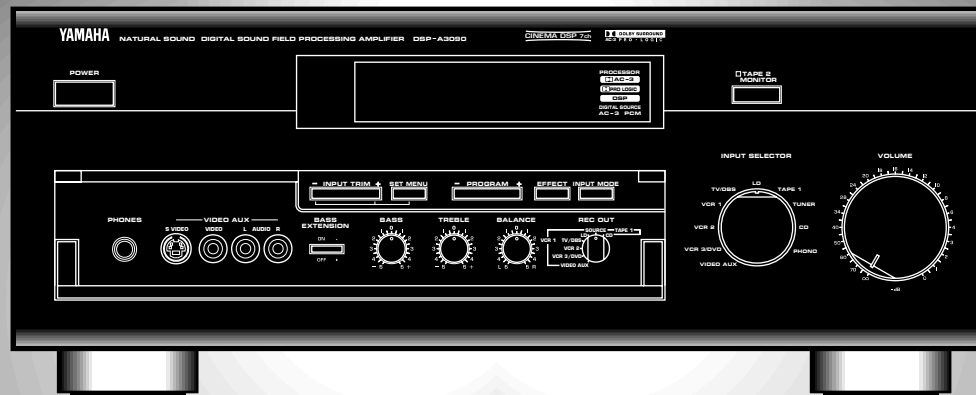

OPERATION MANUAL
MODE D'EMPLOI

PRECAUTIONS & SAFETY INSTRUCTIONS



Active Servo
Technology

CAUTION
RISK OF ELECTRIC SHOCK
DO NOT OPEN



Active Servo
Technology

CAUTION: TO REDUCE THE RISK OF ELECTRIC SHOCK, DO NOT REMOVE COVER (OR BACK). NO USER-SERVICEABLE PARTS INSIDE. REFER SERVICING TO QUALIFIED SERVICE PERSONNEL.

• Explanation of Graphical Symbols



The lightning flash with arrowhead symbol, within an equilateral triangle, is intended to alert you to the presence of uninsulated "dangerous voltage" within the product's enclosure that may be of sufficient magnitude to constitute a risk of electric shock to persons.



The exclamation point within an equilateral triangle is intended to alert you to the presence of important operating and maintenance (servicing) instructions in the literature accompanying the appliance.

WARNING

TO REDUCE THE RISK OF FIRE OR ELECTRIC SHOCK, DO NOT EXPOSE THIS UNIT TO RAIN OR MOISTURE.

IMPORTANT!

Please record the serial number of this unit in the space below.

Model:
Serial No.:

The serial number is located on the rear of the unit.
Retain this Owner's Manual in a safe place for future reference.

SAFETY INSTRUCTIONS

- 1** Read Instructions – All the safety and operating instructions should be read before the unit is operated.
- 2** Retain Instructions – The safety and operating instructions should be retained for future reference.
- 3** Heed Warnings – All warnings on the unit and in the operating instructions should be adhered to.
- 4** Follow Instructions – All operating and other instructions should be followed.
- 5** Water and Moisture – The unit should not be used near water – for example, near a bathtub, washbowl, kitchen sink, laundry tub, in a wet basement, or near a swimming pool, etc.
- 6** Carts and Stands – The unit should be used only with a cart or stand that is recommended by the manufacturer.
- 6A** A unit and cart combination should be moved with care. Quick stops, excessive force, and uneven surfaces may cause the unit and cart combination to overturn.
- 7** Wall or Ceiling Mounting – The unit should be mounted to a wall or ceiling only as recommended by the manufacturer.
- 8** Ventilation – The unit should be situated so that its location or position does not interfere with its proper ventilation. For example, the unit should not be situated on a bed, sofa, rug, or similar surface, that may block the ventilation openings; or placed in a built-in installation, such as a bookcase or cabinet that may impede the flow of air through the ventilation openings.
- 9** Heat – The unit should be situated away from heat sources such as radiators, stoves, or other appliances that produce heat.
- 10** Power Sources – The unit should be connected to a power supply only of the type described in the operating instructions or as marked on the unit.
- 11** Power-Cord Protection – Power-supply cords should be routed so that they are not likely to be walked on or pinched by items placed upon or against them, paying particular attention to cords at plugs, convenience receptacles, and the point where they exit from the unit.
- 12** Cleaning – The unit should be cleaned only as recommended by the manufacturer.
- 13** Nonuse Periods – The power cord of the unit should be unplugged from the outlet when left unused for a long period of time.
- 14** Object and Liquid Entry – Care should be taken so that objects do not fall into and liquids are not spilled into the inside of the unit.



15 Damage Requiring Service – The unit should be serviced by qualified service personnel when:

- A.** The power-supply cord or the plug has been damaged;
or
- B.** Objects have fallen, or liquid has been spilled into the unit;
or
- C.** The unit has been exposed to rain;
or
- D.** The unit does not appear to operate normally or exhibits a marked change in performance;
or
- E.** The unit has been dropped, or the cabinet damaged.

16 Servicing – The user should not attempt to service the unit beyond those means described in the operating instructions. All other servicing should be referred to qualified service personnel.

17 Power Lines – An outdoor antenna should be located away from power lines.

18 Grounding or Polarization – Precautions should be taken so that the grounding or polarization is not defeated.

FCC INFORMATION (for US customers only)

1. IMPORTANT NOTICE : DO NOT MODIFY THIS UNIT!

This product, when installed as indicated in the instructions contained in this manual, meets FCC requirements. Modifications not expressly approved by Yamaha may void your authority, granted by the FCC, to use the product.

2. IMPORTANT : When connecting this product to accessories and/or another product use only high quality shielded cables. Cable/s supplied with this product **MUST** be used. Follow all installation instructions. Failure to follow instructions could void your FCC authorization to use this product in the USA.

3. NOTE : This product has been tested and found to comply with the requirements listed in FCC Regulations, Part 15 for Class “B” digital devices. Compliance with these requirements provides a reasonable level of assurance that your use of this product in a residential environment will not result in harmful interference with other electronic devices.

This equipment generates/uses radio frequencies and, if not installed and used according to the instructions found in the users manual, may cause interference harmful to the operation of other electronic devices.

Compliance with FCC regulations does not guarantee that interference will not occur in all installations. If this product is found to be the source of interference, which can be determined by turning the unit “OFF” and “ON”, please try to eliminate the problem by using one of the following measures:

Relocate either this product or the device that is being affected by the interference.

Utilize power outlets that are on different branch (circuit breaker or fuse) circuits or install AC line filter/s.

In the case of radio or TV interference, relocate/reorient the antenna. If the antenna lead-in is 300 ohm ribbon lead, change the lead-in to coaxial type cable.

If these corrective measures do not produce satisfactory results, please contact the local retailer authorized to distribute this type of product. If you can not locate the appropriate retailer, please contact Yamaha Electronics Corp., U.S.A. 6660 Orangethorpe Ave, Buena Park, CA 90620.

The above statements apply **ONLY** to those products distributed by Yamaha Corporation of America or its subsidiaries.

PRECAUTIONS

1. AVOID EXCESSIVE HEAT, HUMIDITY, DUST AND VIBRATION

Keep the unit away from locations where it is likely to be exposed to high temperatures or humidity—such as near radiators, stoves, etc. Also avoid locations which are subject to excessive dust accumulation or vibration which could cause mechanical damage.

2. INSTALL THE UNIT IN WELL-VENTILATED CONDITION

The openings on the cabinet assure proper ventilation of the unit. If these openings are obstructed, the temperature inside the cabinet will rise rapidly. Therefore, avoid placing objects against these openings, and install the unit in well-ventilated condition. Make sure to allow a space of at least 10 cm behind and on the both sides and at least 20 cm above the top panel of the unit. Otherwise it may not only damage the unit, but also cause fire.

3. KEEP THE AC POWER PLUG DISCONNECTED DURING VACATION ETC.

When not planning to use this unit for long periods of time (ie., vacation, etc.), disconnect the AC power plug from the wall outlet.

4. AVOID PHYSICAL SHOCKS

Strong physical shocks to the unit can cause damage. Handle it with care.

5. DO NOT OPEN THE UNIT OR ATTEMPT REPAIRS OR MODIFICATIONS YOURSELF

This product contains no user-serviceable parts. Refer all maintenance to qualified Yamaha service personnel. Opening the unit and/or tampering with the internal circuitry will make servicing difficult and will endanger you and your unit.

6. DO NOT OPERATE THE UNIT UPSIDE-DOWN

Do not operate the unit upside-down. It may overheat, possibly causing damage.

7. HANDLE THE UNIT GENTLY AND CAREFULLY

Do not use force on switches, knobs or cords. When moving the set, first turn the unit off. Then gently disconnect the power plug and the cords connecting to other equipment. Never pull the cord itself.

8. ALWAYS SET THE VOLUME CONTROL TO MINIMUM

Always set the volume control to “- ∞” before starting audio source play. Increase the volume gradually to an appropriate level after playback has been started.

9. MAKE SURE POWER IS OFF BEFORE MAKING OR REMOVING CONNECTIONS

Always turn power OFF prior to connecting or disconnecting cables. This is important to prevent damage to the unit itself as well as other connected equipment.

10. HANDLE CABLES CAREFULLY

Always plug and unplug cables—including the AC cord—by gripping the connector, not the cord.

11. CLEAN WITH A SOFT DRY CLOTH

Never use solvents such as benzine or thinner to clean the unit. Wipe clean with a soft, dry cloth.

12. KEEP AWAY FROM TUNERS

Digital signals generated by the unit may interfere with other equipment such as tuners, receivers or TVs. Move the system farther away from such equipment if interference is observed.

13. READ THE “TROUBLESHOOTING” SECTION

Be sure to read the “Troubleshooting” section on common operating errors before concluding that your unit is faulty.

14. ABOUT THE AC OUTLETS

Do not connect audio equipment to the AC outlets on the rear panel if that equipment requires more power than the outlets are rated to provide.

We Want You Listening For A Lifetime (for US customers only)

YAMAHA and the Electronic Industries Association's Consumer Electronics Group want you to get the most out of your equipment by playing it at a safe level. One that lets the sound come through loud and clear without annoying blaring or distortion – and, most importantly, without affecting your sensitive hearing. Since hearing damage from loud sounds is often undetectable until it is too late, YAMAHA and the Electronic Industries Association's Consumer Electronics Group recommend you to avoid prolonged exposure from excessive volume levels.



CAUTION (FOR CANADA MODEL)

TO PREVENT ELECTRIC SHOCK, MATCH WIDE BLADE OF PLUG TO WIDE SLOT AND FULLY INSERT.

FOR CANADIAN CUSTOMER

THIS CLASS B DIGITAL APPARATUS MEETS ALL REQUIREMENTS OF THE CANADIAN INTERFERENCE-CAUSING EQUIPMENT REGULATIONS.

This product complies with the radio frequency interference requirements of the Council Directive 82/499/EEC and/or 87/308/EEC.

The apparatus is not disconnected from the AC power source as long as it is connected to the wall outlet, even if the apparatus itself is turned off.

Congratulations!

You are the proud owner of a Yamaha Digital Sound Field Processing (DSP) System—an extremely sophisticated audio component. The DSP system takes full advantage of Yamaha's undisputed leadership in the field of digital audio processing to bring you a whole new world of listening experiences. Follow the instructions in this manual carefully when setting up your system, and the DSP system will sonically transform your room into a wide range of listening environments—anything from a famous concert hall to a cozy jazz club. In addition, you get incredible realism from Dolby-Surround encoded video sources using the built-in Dolby Pro Logic Surround Decoder and Dolby Surround AC-3 Decoder.

Seven built-in channels of amplification on the DSP-A3090 mean that no additional amplifiers are required to enjoy advanced digital sound field processing.

Rather than tell you about the wonders of digital sound field processing, however, let's get right down to the business of setting up the system and trying out its many capabilities. Please read this operation manual carefully and store it in a safe place for later reference.

CONTENTS

PRECAUTIONS & SAFETY INSTRUCTIONS	
.....Inside the front cover	
GETTING STARTED	3
FEATURES	5
SPEAKER SETUP	10
CONTROLS & THEIR FUNCTIONS	13
FRONT PANEL	13
REMOTE CONTROL UNIT	16
CONNECTIONS	18
REAR PANEL PARTS AND THEIR FUNCTIONS	18
REAR PANEL SWITCH AND CONTROL SETTINGS	21
GENERAL INSTRUCTIONS FOR CONNECTIONS.....	21
CONNECTING AUDIO/VIDEO SOURCE EQUIPMENT TO THIS UNIT.....	22
CONNECTING SPEAKER SYSTEMS	26
SELECTING THE OUTPUT MODES SUITABLE FOR YOUR SPEAKER SYSTEM.....	30
ADJUSTMENTS BEFORE OPERATION	33
MAIN/CENTER/EFFECT SPEAKER LEVEL BALANCE ADJUSTMENT.....	33
INPUT LEVEL ADJUSTMENT	35
ADJUSTMENTS IN THE “SET MENU” MODE	36
GENERAL OPERATION	45
PLAYING A SOURCE.....	45
RECORDING A SOURCE TO AUDIO/VIDEO TAPE (OR DUBBING FROM A TAPE TO ANOTHER).....	48
SELECTING SOUND FIELD PROGRAMS	49
MUTING THE EFFECT SOUND.....	51
SUPERIMPOSED VIDEO PROGRAM/PARAMETER DISPLAY	51
DESCRIPTIONS OF THE SOUND FIELD PROGRAMS	52
CREATING YOUR OWN SOUND FIELDS	58
SELECTING AND EDITING PROGRAM PARAMETERS	58
DESCRIPTIONS OF THE DIGITAL SOUND FIELD PARAMETERS.....	60
REMOTE CONTROL LEARNING FUNCTION	64
TROUBLESHOOTING	66
SPECIFICATIONS	68

GETTING STARTED

Unpacking

If you haven't already done so, carefully remove this unit and its accessories from the box and wrapping material. You should find the unit itself and the following accessories.

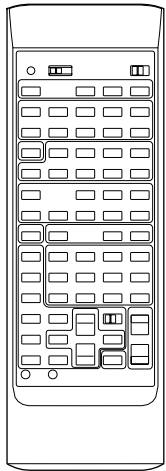

Remote control

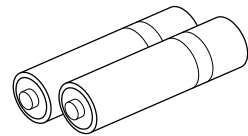

Batteries

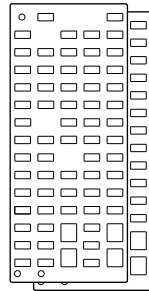

User program sheets

Installing the Remote Control Unit Batteries

Since the remote control unit will be used for many of this unit's control operations, you should begin by installing the supplied batteries.

1. Turn the remote control unit over and slide the battery compartment cover downward in the direction of the arrow.

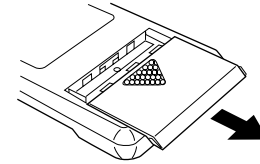

2. Insert the batteries (LR6, AA, UM-3 type), being careful to align them with the polarity markings on the inside of the battery compartment.

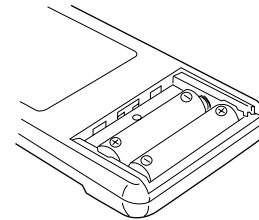

3. Close the battery compartment cover.

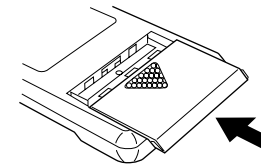

Notes about the Remote Control Unit

- When you notice that remote control operation has become erratic, or the distance from which the remote control will function has decreased, it's time to replace the batteries. Always replace all batteries at the same time.
 - * If you have exchanged batteries in the remote control unit with new ones, press the RESET button before using the remote control unit.
- Make sure that the YPC/USER/LEARN switch on the remote control unit is set to the YPC or USER position for normal operation.
- This remote control uses an advanced, highly directional infrared beam. Be sure to aim the remote control directly at the remote control sensor on the main unit when operating.

Remote control transmitter operation range

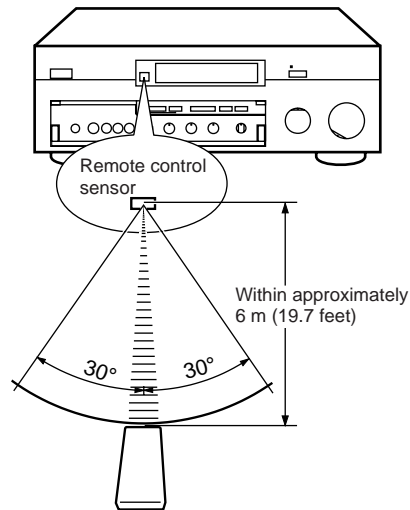

Notes

- There should be no large obstacles between the remote control transmitter and the main unit.
- If the remote control sensor is directly illuminated by strong lighting (especially an inverter type of fluorescent lamp etc.), it might cause the remote control transmitter to work incorrectly. In this case, reposition the main unit to avoid direct lighting.

Open/close the control door

When it is not necessary to operate controls inside the control door, close the door.

To open the door

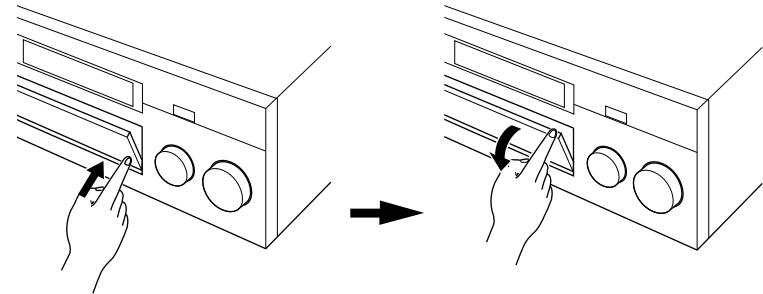

To close the door

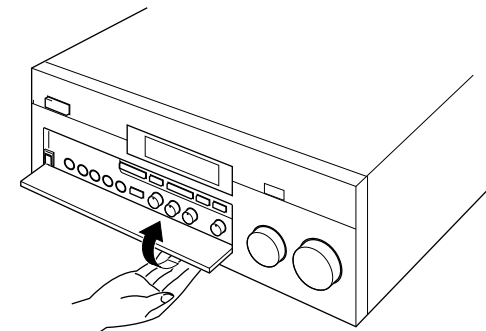

FEATURES

This unit incorporates a sophisticated, multi-program digital sound field processor. The processor allows you to electronically expand and change the shape of the audio sound field from both audio and video sources, creating a theater-like experience in your listening room. This unit has a total of 12 digital sound field processor (DSP) modes. You can create an excellent audio sound field by selecting a suitable sound field (this will, of course, depend on what you will be listening to), and adding desired adjustments.

In addition, this unit incorporates a Dolby Pro Logic Surround decoder and Dolby Surround AC-3 decoder for multi-channel sound reproduction of Dolby Surround encoded video sources. The operation of the Dolby Pro Logic Surround or Dolby Surround AC-3 decoder can be controlled by selecting a corresponding DSP program including combined operations of the Yamaha DSP and the Dolby Pro Logic Surround or Dolby Surround AC-3 decoder.

Digital Sound Field Processing

What is it that makes live music so good? Today's advanced sound reproduction technology lets you get extremely close to the sound of a live performance, but chances are you'll still notice something missing, the acoustic environment of the live concert hall. Extensive research into the exact nature of the sonic reflections that create the ambience of a large hall has made it possible for Yamaha engineers to bring you this same sound in your own listening room, so you'll feel all the sound of a live concert. What's more, our technicians, armed with sophisticated measuring equipment, have even made it possible to capture the acoustics of a variety of actual concert halls, jazz clubs, theaters, etc. from around the world, to allow you to accurately recreate any one of these live performance environments, all in your own home.

Dolby Pro Logic Surround

This unit employs a Dolby Pro Logic Surround decoder similar to professional Dolby Stereo decoders used in many movie theaters. By using the Dolby Pro Logic Surround decoder, you can experience the dramatic realism and impact of Dolby Surround movie theater sound in your own home. Dolby Pro Logic employs a four channel five speaker system. The Pro Logic Surround system divides the input signal into four levels: the left and right main channels, the center channel (used for dialog), and the rear surround sound channels (used for sound effects, background noise, and other ambient noises). The center channel allows listeners seated in even less-than-ideal positions to hear the dialog originating from the action on the screen while experiencing good stereo imaging. Dolby Surround is encoded on the sound track of pre-recorded video tapes, laser discs, and some TV/cable broadcasts. When you play a source encoded with Dolby Surround on this unit, the Dolby Pro Logic Surround decoder decodes the signal and distributes the surround-sound effects.

This Dolby Pro Logic Surround Decoder employs a digital signal processing system. This system improves the stability of sound at each channel and crosstalk between channels, so that positioning of sounds around the room is more accurate compared with conventional analog signal processing systems.

In addition, this unit features a built-in automatic input balance control. This always assures you the best performance without manual adjustment.

Dolby Surround AC-3

The built-in Dolby Surround AC-3 Decoder leads you into a totally new sound experiences.

Dolby Surround AC-3 is a new generation of multi-channel digital audio technology, or the newest spatial sound processing format developed for 35 mm film-movies by employing a new kind of low bit-rate audio coding.

Dolby Surround AC-3 is a digital surround sound system that provides completely independent multi-channel audio to consumers. In multi-channel form, Dolby Surround AC-3 provides five full range channels in what is sometimes referred to as a "3/2" configuration: three front channels (left, center and right), plus two surround channels. A sixth bass-only effect channel is also provided for output of LFE (low frequency effect), or low bass effects that are independent of other channels. This channel is counted as 0.1, thus giving rise to the term 5.1 channels in total.

Compared to Dolby Pro Logic that is referred to a "3/1" system (left front, center, right front and just one surround channel), Dolby Surround AC-3 features two surround channels, called stereo or split surrounds, each offering the same full range fidelity as the three front channels.

Sound of wide dynamic range reproduced by the five full range channels presents listeners much excitement that has never been experienced before. Precise sound orientation by the discrete digital sound processing expands realism that the original movie possesses.

Laser Disc is a home audio format that could benefit from Dolby AC-3. In the near future, Dolby AC-3 will also be applied to DBS, CATV, DVD and HDTV. The ongoing release of Dolby Stereo Digital theatrical films now underway will provide an immediate source of AC-3 encoded video software.



Manufactured under license from Dolby Laboratories Licensing Corporation. "Dolby", "AC-3", "Pro Logic", and the double-D symbol are trademarks of Dolby Laboratories Licensing Corporation. Copyright 1992 Dolby Laboratories, Inc. All rights reserved.

The following original functions make the surround-sound effect of Dolby Surround AC-3 become the most suitable for your audio system and the listening conditions.

- **Dynamic range (sound scale) of source can be changed so that it will be suitable for the listening conditions.**
- **Output of low bass from any channel can be assigned to either the MAIN SPEAKERS terminals or SUBWOOFER terminals to maximize system performance.**
- **Output of LFE can be assigned to either the MAIN SPEAKERS terminals or SUBWOOFER terminals to maximize system performance.**

Dolby Surround + DSP (CINEMA DSP)

Dolby Surround sound system shows its full ability in a large movie theater, because movie sounds are originally designed to be reproduced in a large movie theater using many speakers. It is difficult to create a sound environment similar to that of a movie theater in your listening room, because the room size, materials of inside walls, the number of speakers, etc. of your listening room is much different from those of a movie theater.

Yamaha DSP technology made it possible to present you with nearly the same sound experience as that of a large movie theater in your listening room by compensating for lack of presence and dynamics in your listening room with its original digital sound fields combined with Dolby Surround sound field.

CINEMA DSP 7ch

The YAMAHA "CINEMA DSP" logo indicates those programs are created by the combination of Dolby Surround and YAMAHA DSP technology.

Dolby Pro Logic + 2 Digital Sound Fields

A digital sound field is created on the presence side and the rear surround side of the Dolby Pro Logic Surround-processed sound field individually. They create a wide acoustic environment and emphasize surround-effect in the room, letting you feel much presence as if you are watching a movie in a popular Dolby Stereo theater.

This combination is used on sound field programs No. 7 through No. 11, and “PROLOGIC/Enhanced” of No. 12.

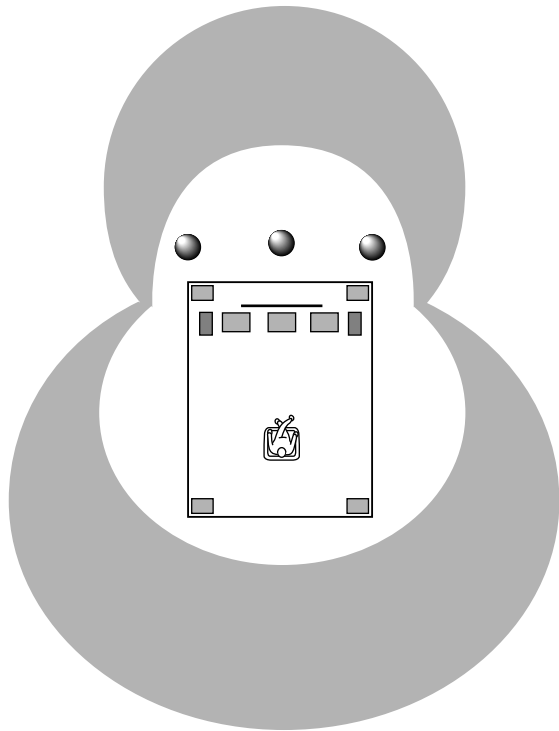

Dolby Surround AC-3 + 3 Digital Sound Fields

A digital sound field is created on the presence side and the independent left and right surround sides of the Dolby Surround AC-3-processed sound field individually. They create a wide acoustic environment and much surround effect in the room without losing high channel separation. With wide dynamic range of AC-3 sound, this sound field combination lets you feel as if you are watching a movie in the newest Dolby Stereo Digital theater. This will be the most ideal home theater sound at the present time.

This combination is available on the sound field programs No. 7 through No. 11 and “AC-3/Enhanced” of No. 12 when playing a source with the Dolby Surround AC-3 decoded.

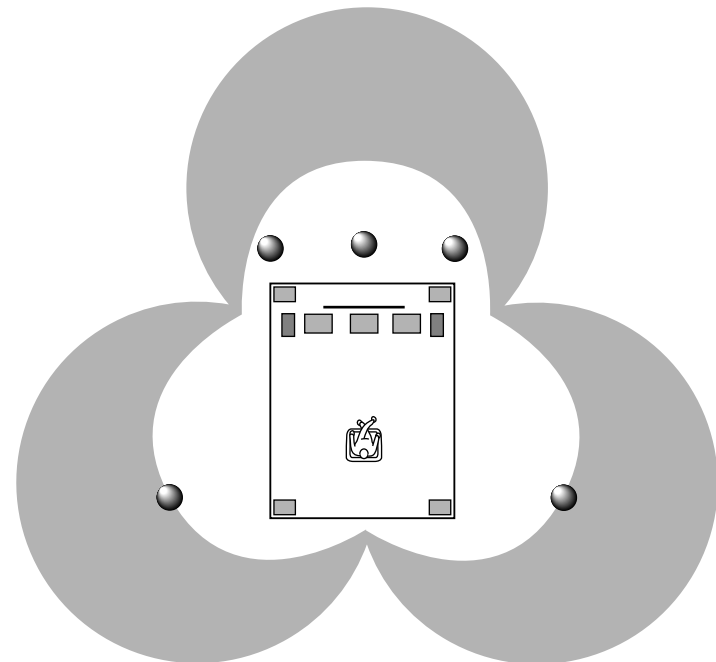

Video superimpose

If you connect your video cassette recorder, LD player, video monitor, etc. to this unit, you can take advantage of this unit's capability to display program titles, parameter data and information for various setting changes and adjustments on your video monitor's screen. This information will be superimposed over the video image.

If there is no video source connected or it is turned off, the information will be displayed over a blue colored background.

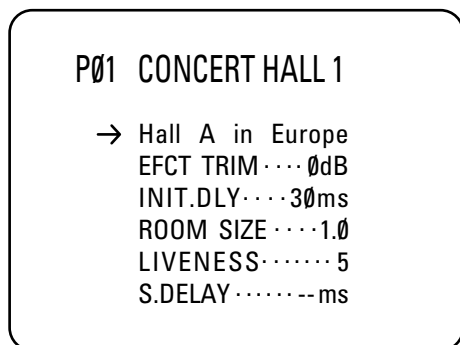

NOTE: The program titles, parameter data and other information are also displayed on the display panel of this unit.



SPEAKER SETUP

Setting Up Your Speaker System

This unit has been designed to provide the best sound field quality with a full seven-speaker system setup, using two extra pairs of effect speakers to generate the sound field plus one center speaker for dialog. We therefore recommend that you use a seven-speaker setup. A four-speaker system using only one pair of effect speakers for the sound field will still provide impressive ambience and effects, however, and may be a good way to begin with this unit. You can always upgrade to the full seven speaker system later. In the 4 or 5 speaker system, the Digital Sound Field Processing is still performed, but the main speakers are used for both the main channels and the front effect channels.

Use of the Center Dialog Speaker Is Recommended

When playing back a source with the "CINEMA DSP" programs No. 7 through No. 12, or when the Dolby Surround AC-3 is decoded with any DSP program used, dialog, vocals etc. are output from the center channel. Therefore, if you want to maximize the performance of your Audio/Video home theater system, it is recommended that you use a center channel speaker.

If for some reason it is not practical to use a center speaker, it is possible to enjoy movie viewing without it. Best results, however, are obtained with the full system.

Use of a Subwoofer Expands Your Sound Field

It is also possible to further expand your system with the addition of a subwoofer and amplifier. The use of a subwoofer is effective not only for reinforcing bass frequencies from any or all channels, but also for reproducing the LFE (low frequency effect) sound with high fidelity when playing back a source with the Dolby Surround AC-3 decoded. You may wish to choose the convenience of a Yamaha Active Servo Processing Subwoofer System, which has its own built-in power amp.

Four Possible Types of Speaker System Configurations Recommended

4 Speaker System

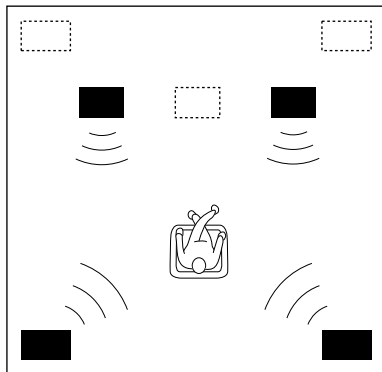

Simplest system.

You can enjoy widely diffused sound by only adding two additional speaker units at the rear.

FRONT MIX switch—Set to ON.
(See page 21.)
CENTER SP—Set to PHNTM.
(See page 30.)

5 Speaker System

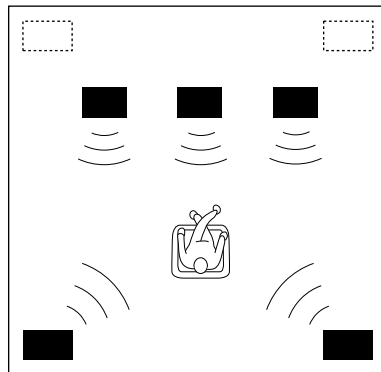

Good for Audio/Video sources.

By the use of center speaker, center sounds (dialog, vocals etc.) are precisely localized.

FRONT MIX switch—Set to ON.
(See page 21.)
CENTER SP—Set to NRML or WD.
(See page 30.)

6 Speaker System

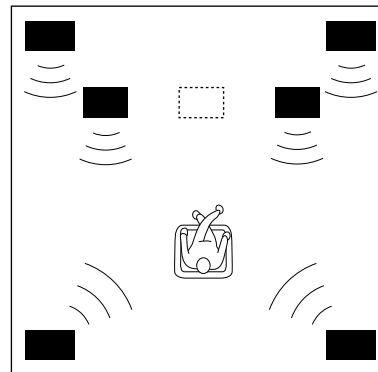

Good for sound fields from 2-channel stereo sources.

When a normal stereo source is played back with the sound field programs No. 1 through No. 6, a sound effect matching that of a 7-speaker system can be obtained. The addition of front left and right effect speakers produces a more effective sound field.

FRONT MIX switch—Set to OFF.
(See page 21.)
CENTER SP—Set to PHNTM.
(See page 30.)

7 Speaker System

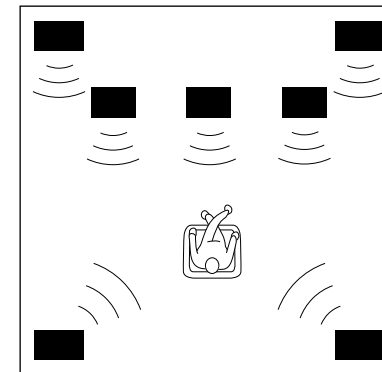

This is the recommended speaker system, providing the best sound effects.

When a normal stereo source is played back with the sound field programs No. 1 through No. 6, using both sets of effect speakers (front and rear), reproduces the most effective sound field. When using the the sound field programs No. 7 through No. 12 or when decoding the Dolby Surround AC-3 with any program used, the center speaker provides precise center localization.

FRONT MIX switch—Set to OFF.
(See page 21.)
CENTER SP—Set to NRML or WD.
(See page 30.)

Speakers and Speaker Placement

Your full seven-speaker system will require three speaker pairs: the MAIN SPEAKERS (your normal stereo speakers), the FRONT EFFECT SPEAKERS and the REAR EFFECT SPEAKERS, plus the CENTER SPEAKER. You may also be using a subwoofer.

The MAIN SPEAKERS should be high performance models and have enough power handling capacity to accept the maximum output of your audio system.

Other speakers do not have to be equal to the MAIN SPEAKERS. For precise sound localization, however, it is ideal to use high performance models that can reproduce sounds in full range for the CENTER SPEAKER and the FRONT and REAR EFFECT SPEAKERS.

Place the MAIN SPEAKERS in the normal position.

Place the FRONT EFFECT SPEAKERS further apart than the MAIN SPEAKERS, on either side of and a few feet behind and above the MAIN SPEAKER pair.

Place the REAR EFFECT SPEAKERS behind your listening position. They should be nearly six feet up from the floor.

Place the CENTER SPEAKER precisely between the two MAIN SPEAKERS. (To avoid interference, keep the speaker above or below the television monitor, or use a magnetically shielded speaker.)

If using a SUBWOOFER, such as a Yamaha Active Servo Subwoofer System, the position of the speaker is not so critical because low bass tones are not highly directional.

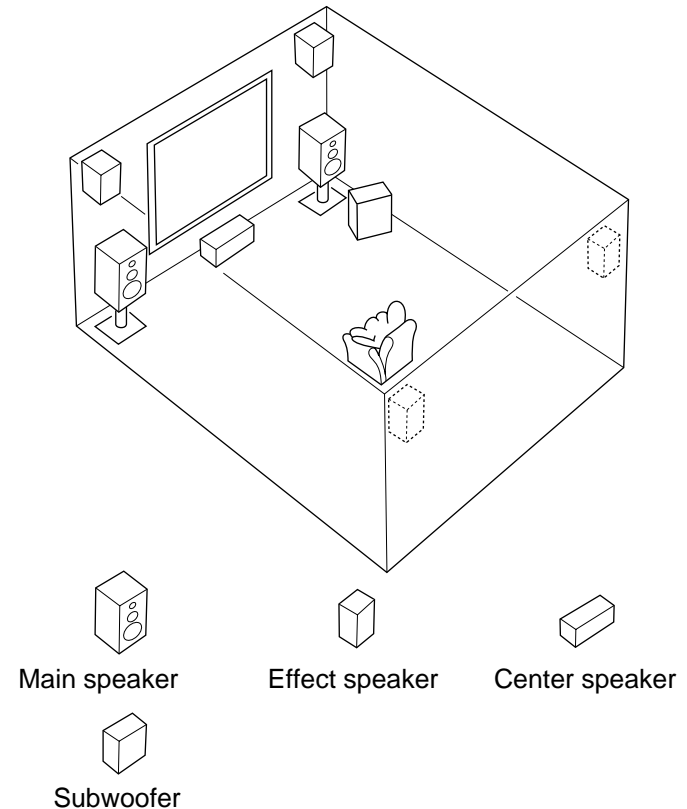

CONTROLS & THEIR FUNCTIONS

FRONT PANEL

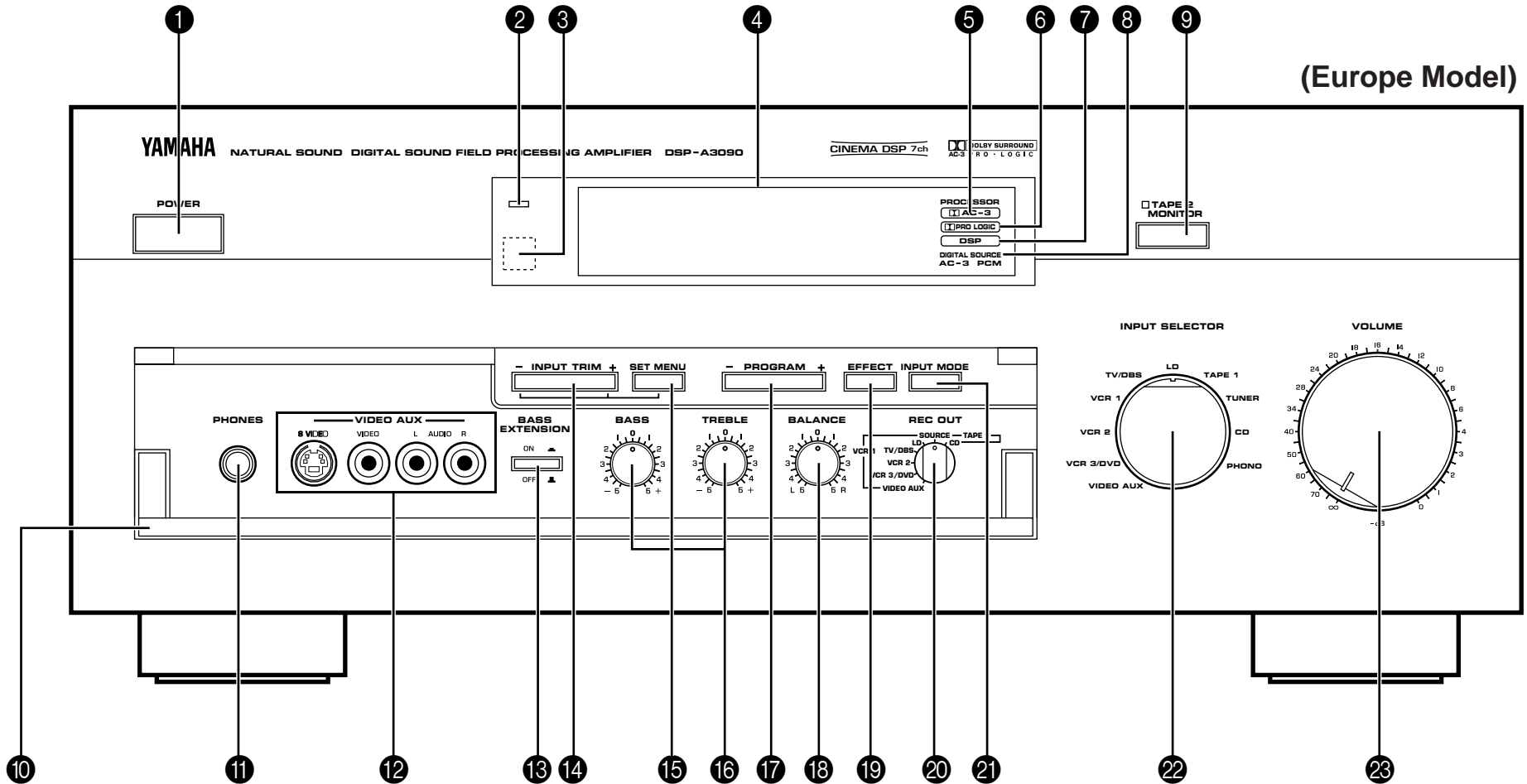

- ① **POWER Switch**
Turns this unit on and off.
- ② **Standby Indicator (Europe, U.K. and Australia models only)**
While the power of this unit is on, pressing the POWER key on the remote control unit switches this unit to the standby mode. In this mode, the standby indicator is half illuminated.
- ③ **Remote Control Sensor**
Signals from the remote control unit are received here.
- ④ **Display Panel**
Shows program names, parameters and information for various setting changes and adjustments.
- ⑤ **□□ AC-3 Indicator**
Lights up while the built-in Dolby Surround AC-3 Decoder is functioning.
- ⑥ **□□ PRO LOGIC Indicator**
Lights up while the built-in Dolby Pro Logic Surround Decoder is functioning.
- ⑦ **DSP Indicator**
Lights up while the built-in Digital Sound Field Processor is functioning.
- ⑧ **DIGITAL SOURCE AC-3/PCM Indicator**
“AC-3” lights up when a Dolby Surround AC-3 encoded signal is input to this unit. “PCM” lights up when a digital signal other than Dolby Surround AC-3 encoded signals is input to this unit.
- ⑨ **TAPE 2 MONITOR Switch**
Used when you have connected a second tape deck to this unit's AUDIO SIGNAL TAPE 2 jacks to select that tape as the source.
- ⑩ **Control Door**
See page 4 for how to open and close the control door.
- ⑪ **PHONES Jack**
Plug in headphones here for private listening. Sound signals from the main channels only are output here. However, if the Dolby Surround AC-3 is decoded, signals at all channels are distributed to the main channels and output here.
- ⑫ **Auxiliary Input Jacks (VIDEO AUX)**
Connect an auxiliary video or audio unit such as a camcorder to these jacks. If the connected video unit has a S video output terminal, connect it to the S VIDEO jack to obtain a high resolution picture. The unit connected to these jacks can be selected by the INPUT SELECTOR and REC OUT selector.
- ⑬ **BASS EXTENSION Switch**
When pressed inward (ON), boosts bass frequency response at the main left and right channels while maintaining overall tonal balance. If you do not have a subwoofer, the use of this switch will be effective to reinforce the bass frequencies.
* The use of this switch will not be so effective if you set the function “1. SPEAKER SET” in the SET MENU mode to output low bass signals at the main channels from the subwoofer only. (See pages 30–32 for details.)
- ⑭ **INPUT TRIM Control**
Adjusts the input level of each source respectively. Moreover, performs setting changes and adjustments for functions selected in the SET MENU mode.
- ⑮ **SET MENU Switch**
Whenever pressed, selects functions in the SET MENU mode.

- ①⑥ **BASS and TREBLE Controls**
Adjust low and high frequency response respectively for the left main, right main and center channels only.
* Increasing low frequency response with the BASS control will not be so effective if you set the function “1. SPEAKER SET” in the SET MENU mode to output low bass signals at the main channels and/or the center channel from the subwoofer. (See pages 30–32 for details.)
- ①⑦ **PROGRAM Selector**
Sequentially selects the digital sound field processing programs in the + or – direction.
- ①⑧ **BALANCE Control**
Adjusts the left and right output volume to the Main Speakers to compensate for sound imbalance caused by speaker positions or listening room conditions.
- ①⑨ **EFFECT Switch**
Normally ON, this switch can be turned OFF to disable output from the center and effect speakers so that the sound becomes normal 2-channel stereo.
* Even if this switch is off, when the Dolby Surround AC-3 is decoded, signals at all channels are distributed to the main channels and output from the main speakers.
- ②⑩ **RET OUT Selector**
Selects the source to be recorded to a tape deck 1 or VCR 1 independently of the setting of the INPUT SELECTOR. However, when set to the SOURCE position, the setting of the INPUT SELECTOR decides the source to be recorded to a tape deck or VCR.
- ②① **INPUT MODE Switch**
Switches the mode of selecting input signals between “AUTO” and “ANALOG” modes for sources that input two or more types of signals to this unit. (See page 46 for details.)
* For LD source, this switches among “AUTO”, “AC-3 RF”, “DIGITAL” and “ANALOG” modes.
- ②② **INPUT SELECTOR**
Selects the input source that you want to listen to (and watch).
- ②③ **Master VOLUME Control**
Simultaneously controls volume level at all outputs: front effect, main, rear effect, center, and subwoofer. (This does not affect TAPE REC OUT level.)
* When the volume is decreased by pressing the MUTING key on the remote control unit, the indicator on the master VOLUME control flashes on and off.

REMOTE CONTROL UNIT

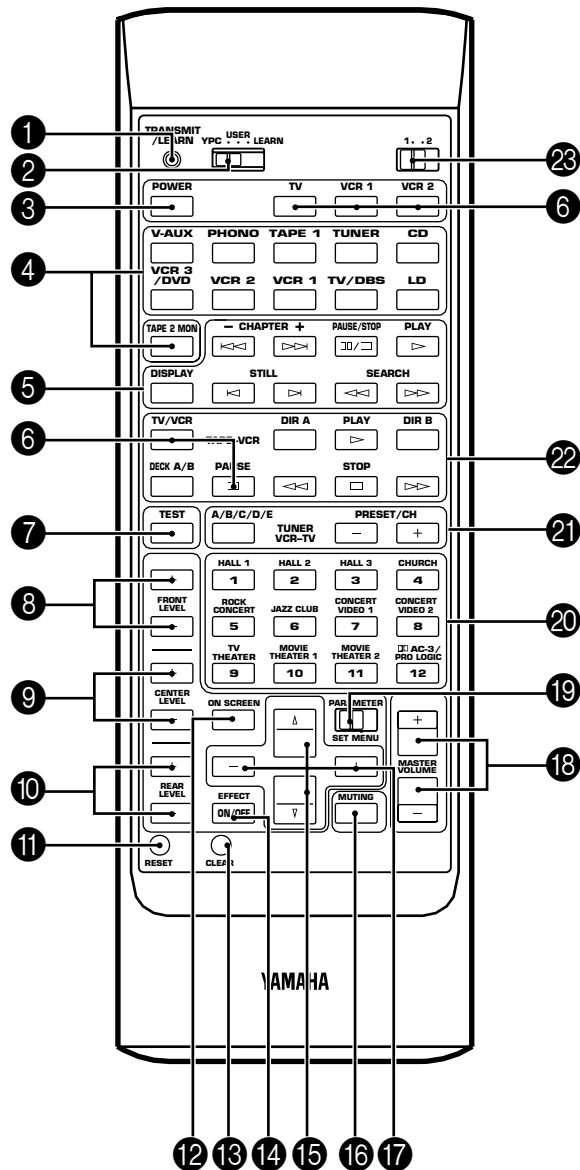

- 1** TRANSMIT/LEARN Indicator
In “LEARN” mode, lights to indicate that the key just pressed is ready for learning input. In “USER” mode, blinks when a learned key is pressed to show that a control signal has been sent to your equipment.
- 2** YPC/USER/LEARN Switch
Set to YPC for operating this unit and Yamaha Audio/Video units. Set to USER for using learned key functions. Set to LEARN for learning new control functions. (See page 64.) (“YPC” is the abbreviation of YAMAHA Preset Code.)
- 3** POWER Key
Turns this unit on and off.
* (Europe, U.K. and Australia models only)
Turns the power on mode to the standby mode and vice versa.
- 4** Input Selector Keys
Select the input source. Pressing the key for the currently selected source will change its input mode. (See page 45 for details.)
- 5** CD/LD Function Keys
Operate functions on your Yamaha CD player and LD player. When the 1/2 Switch is set to 1, they operate the CD player, and when set to 2, they operate the LD player.
- 6** Blank Keys
Have no preset functions, so are used for learning other remote controller’s functions only.
- 7** TEST Switch
When pressed, sends a signal to the main left, center, main right, rear right effect and rear left effect speaker in turn, and when pressed once again, sends a signal to the main and front effect speakers in turn for easy comparison of level settings.

- 8 FRONT LEVEL +/- Keys
Increase (+) or decrease (-) the volume level of the front effect speakers.
- 9 CENTER LEVEL +/- Keys
Increase (+) or decrease (-) the volume level of the center speaker(s).
- 10 REAR LEVEL +/- Keys
Increase (+) or decrease (-) the volume level of the rear effect speakers. Pressing these keys change both of the right and left effect speaker's levels at the same time with the level balance between them unchanged. To change the level balance between the right and left effect speakers, follow the instruction on page 33.
- 11 RESET Button
Press this button to "reset" the internal microcomputer which controls remote control operations. Microcomputer "reset" is necessary when the remote control freezes. If you have exchanged batteries in the remote control unit with new ones, press the RESET button before using the remote control unit.
* Pressing the RESET button will not erase learned functions.
- 12 ON SCREEN Display Key
Changes the type of display showing the program name and parameters, or information for various setting changes and adjustments on the connected monitor's screen.
Whenever pressed, the screen changes to a full display, a simple display and no display in turn.
- 13 CLEAR Button
Used in USER or LEARN mode to erase a learned function. (See page 65.)
- 14 EFFECT ON/OFF Key
Normally ON, this key can be turned OFF to disable output from the center and effect speakers so that the sound becomes normal 2-channel stereo.
- 15 Parameter Select Keys
Select DSP program parameters, or titles of the functions in the SET MENU mode.
- 16 MUTING Key
Decreases the master volume level by 20 dB. While muting, the indicator on the master VOLUME control flashes on and off continuously.
- 17 Parameter +/- Keys
Edit DSP program parameters or used for setting changes and adjustments in the SET MENU mode.
- 18 MASTER VOLUME +/- Keys
Increase (+) or decrease (-) the master volume level.
- 19 PARAMETER/SET MENU Switch
When set to the PARAMETER position, the Parameter Select Keys and Parameter +/- Keys will select and edit DSP program parameters. When set to the SET MENU position, the Parameter Select Keys and Parameter +/- Keys are used for setting changes and adjustments in the SET MENU mode.
- 20 Program Select Keys (1 through 12)
Select DSP programs 1 through 12.
- 21 Tuner Function Keys
Operate Yamaha tuner functions.
- 22 Tape Deck Function Keys
Operate Yamaha tape deck functions.
- 23 1/2 Switch
When the YPC/USER/LEARN Switch is set to YPC, this switches the CD/LD Function Keys to keys for use with either the CD player or LD player. ("1" for the CD player and "2" for the LD player.) When the YPC/USER/LEARN Switch is set to USER or LEARN, this switch selects the group 1 or 2 of the learnable function keys. (See page 64.)

CONNECTIONS

REAR PANEL PARTS AND THEIR FUNCTIONS

Before you start making connections make sure all related electronic components are turned OFF.

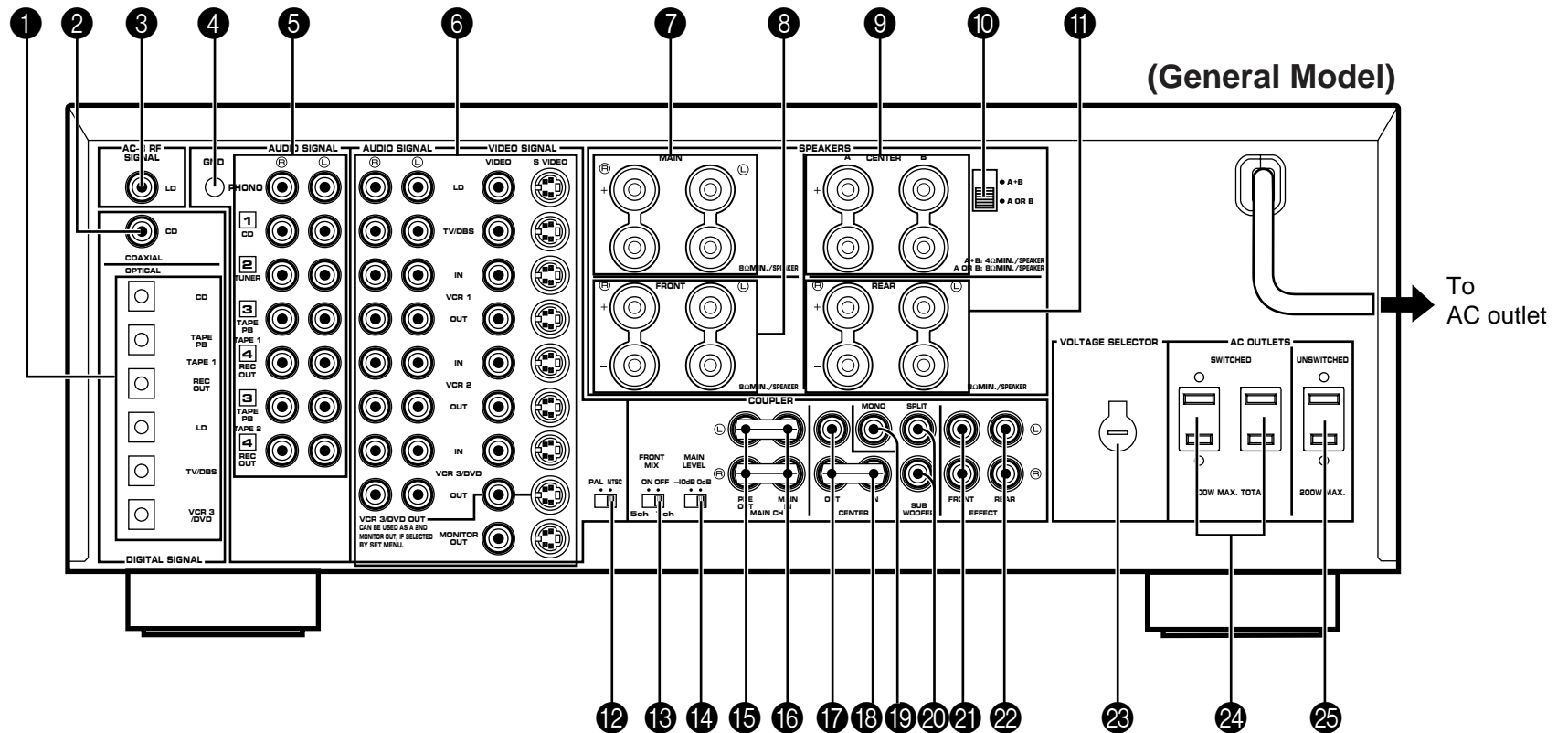

- 1 OPTICAL Digital Input and Output Jacks**
Can be connected with audio/video units that have optical digital signal output (and input) jacks.
- 2 COAXIAL Digital Input Jack (for CD Player)**
Can be connected with a CD player that has a coaxial digital signal output jack.
- 3 AC-3 RF SIGNAL Input Jack (for LD player)**
Can be connected with an LD player that has an AC-3 RF audio signal output jack.
- 4 GND Terminal**
Connects the ground wire of the turntable to produce minimum hum. In some cases, however, better results may be obtained with the ground wire disconnected.
- 5 AUDIO SIGNAL Connection Jacks (for Audio Source Equipment)**
Connect the inputs and/or outputs of your audio equipment.
- 6 AUDIO/VIDEO SIGNAL Connection Jacks (for Video Source Equipment)**
Connect the audio and video inputs and/or outputs of your video equipment. In place of the VIDEO jacks, the S VIDEO jacks can be used for higher resolution and improved picture quality if your VCR, monitor, etc. are equipped with S-VIDEO connectors.
- 7 MAIN SPEAKERS Terminals**
When using this unit's built-in main-channel amplifier, connect the main speakers here. The jumper bars must be plugged in to connect the MAIN IN jacks to the PRE OUT jacks.
- 8 FRONT SPEAKERS Terminals**
When using the built-in front-channel amplifier, connect the front effect speakers here.
- 9 CENTER SPEAKERS Terminals**
When using the built-in center-channel amplifier, connect one or two center speakers here.
- 10 Center Speaker Impedance Switch**
Set to "A + B" when using two center speakers, or to "A OR B" when using only one center speaker.
- 11 REAR SPEAKERS Terminals**
When using the built-in rear-channel amplifier, connect the rear effect speakers here.
- 12 Video NTSC/PAL Switch (General Model only)**
Set this switch to the position corresponding to the standard that your video equipment employs.
- 13 FRONT MIX Switch**
Set to "OFF (7ch)" when setting up a full 7 or 6 speaker system, or to "ON (5ch)" when setting up a 5 or 4 speaker system.
- 14 MAIN LEVEL Switch**
Normally set to "0 dB". If desired, you can decrease the main-channel output level at the MAIN SPEAKERS terminals by 10 dB by setting this switch to "-10 dB".
- 15 PRE OUT Jacks**
Main-channel line output. Connected with jumper bars to MAIN IN jacks when the built-in amplifier is used. Connected to input jacks of external stereo power amplifier (MAIN IN or TAPE PLAY jacks of integrated amplifier or receiver) when using external amplification.
- 16 MAIN IN Jacks**
Line input to built-in main-channel amplifier. Connected with jumper bars to PRE OUT jacks when the built-in amplifier is used. Not connected when using an external power amplifier.

17 CENTER OUT Jacks

Center-channel line outputs. The CENTER OUT jack at the lower part is connected with the jumper bar to the CENTER IN jack when the built-in amplifier is used. Can be connected to input jack(s) of one or two external power amplifier(s) to drive the center speaker(s).

18 CENTER IN Jack

Line input to built-in center-channel amplifier. Connected with the jumper bar to CENTER OUT jack when the built-in amplifier is used. Not connected when using an external power amplifier.

19 MONO SUBWOOFER Jack

When using a subwoofer, connect its amplifier input to this jack. Frequencies below 90 Hz distributed from the main, center and/or rear channels are output to this jack. Signals of LFE (low frequency effect) generated when the Dolby Surround AC-3 is decoded are also output if they are assigned to this jack.

20 SPLIT SUBWOOFER Jacks

When using two subwoofers, connect their amplifiers to these jacks. Low bass signals that are output to the MONO SUBWOOFER jack are also output to these jacks. However, signals from the left main and left rear channels are output to the SPLIT L jack, and signals from the right main and right rear channels are to the SPLIT R jack separately.

21 FRONT EFFECT Out Jacks

Front-channel line output. Not connected when the built-in amplifier is used. Can be connected to input jacks of an external stereo power amplifier driving the front effect speakers.

22 REAR EFFECT Out Jacks

Rear-channel line output. Not connected when the built-in amplifier is used. Can be connected to input jacks of an external stereo power amplifier driving the rear effect speakers.

23 VOLTAGE SELECTOR (General Model only)

Be sure to set to the line voltage in your area before applying power. Consult your dealer if unsure of the correct setting.

24 SWITCHED AC OUTLETS

You may plug other audio/video units into these sockets as long as their combined power consumption does not exceed the specified value shown. "Switched" means that these components are turned on and off by this unit's power switch.

25 UNSWITCHED AC OUTLET (U.S.A., Canada and General Models only)

The total power consumption of audio/video units plugged into this socket should not exceed the specified value shown. "Unswitched" means that power is available even when this unit is off.

NOTE: If an external power amplifier is connected to the FRONT EFFECT or REAR EFFECT output jacks, the corresponding internal amplifier will be turned off and no output will be available at the SPEAKERS terminals.

REAR PANEL SWITCH AND CONTROL SETTINGS

There are several switches and controls on the rear panel that you'll have to check before operating your system, and it's a good idea to do it before you connect cables. Locate the MAIN LEVEL slide switch (14) and FRONT MIX slide switch (13). Make sure the MAIN LEVEL switch is set to "0 dB" and the FRONT MIX switch is set to "OFF" for 7 or 6 speaker driving.

In a 5 or 4 speaker system, set the FRONT MIX switch to "ON".

Next, set the NTSC/PAL switch (12) to the position corresponding to the standard which your video equipment employs. (General Model only)

GENERAL INSTRUCTIONS FOR CONNECTIONS

Make sure that you have the left (L) and right (R) channels correctly connected. That means that jacks marked "L" on this unit must be connected to jacks marked "L" on other units. Likewise with the "R" jacks. This is easy if you remember to always use the red plug for the "R" jacks and the white plug for the "L" jacks.

For connections with audio/video source equipment, use RCA type pin plug cables with the exception described later.

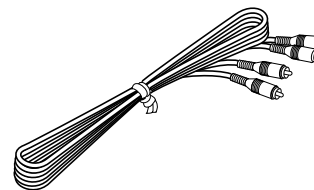

With speaker connections you must also be sure that the polarity is correct. For each amplifier and each channel, connect the plus (+) terminal of the amplifier to the plus terminal of the speaker, and connect the minus (-) terminal of the amplifier to the minus terminal of the speaker. To keep track of polarity, use a speaker cable that has one of the two wires marked by a stripe or a different color.

CONNECTING AUDIO/VIDEO SOURCE EQUIPMENT TO THIS UNIT

BASIC CONNECTIONS

- * If you have YAMAHA audio/video unit numbered as 1, 2, 3, etc. on the rear panel, connections can be made easily by making sure to connect the output (or input) terminals of each unit to the same-numbered terminals of this unit.

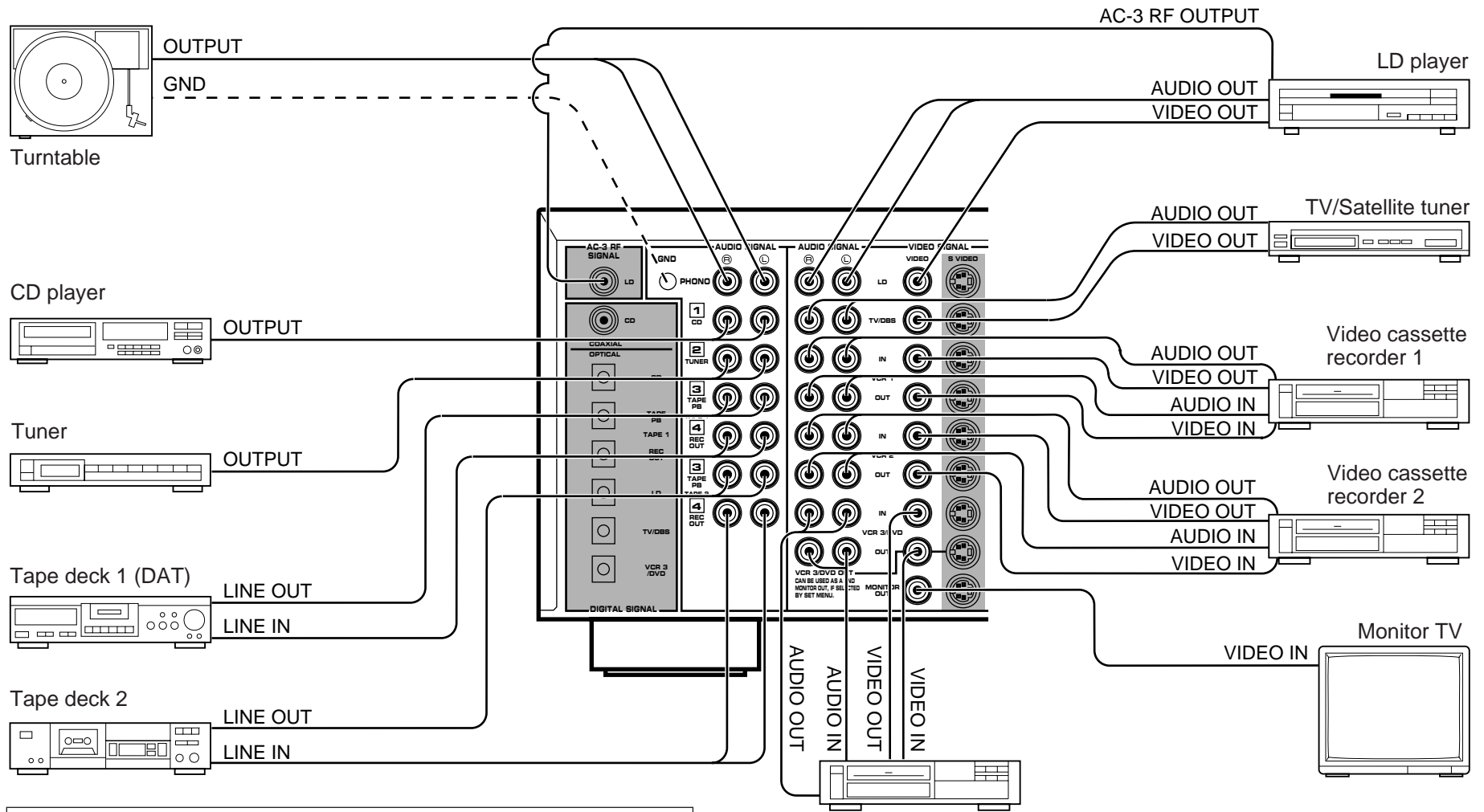

If you wish to connect a second monitor TV (or a projector) to this unit, you can switch the VCR 3/DVD VIDEO OUT jack (and S VIDEO jack also) to a second monitor out jack for the connection with another monitor TV. (See page 43.)

Video cassette recorder 3 or another video unit

* For shaded parts, see pages 23 to 25.

CONNECTING TO DIGITAL (OPTICAL AND COAXIAL) JACKS

If your CD player, video cassette recoder, LD player, etc. are equipped with optical digital audio signal output (and input) jacks, they can be connected to this unit's OPTICAL digital signal input (and output) jacks.

To make a connection between optical digital audio signal jacks, remove the cover from each jack, and then connect them by using a commercially available optical fiber cable that conforms to EIAJ standards. Other cables might not function correctly.

Additionally, this unit is equipped with a COAXIAL type of digital audio signal input jack for the connection with the CD player only, so you can select either the OPTICAL or the COAXIAL jack for a digital connection with the CD player.

Even if you connect an audio/video unit to the OPTICAL (or COAXIAL) jack of this unit, you must keep the unit connected with the same named analog audio signal jacks of this unit, because digital signal cannot be recorded by a tape deck or VCR other than the tape deck connected to the OPTICAL TAPE 1 REC OUT jack of this unit. You can switch the selection of input signals between "digital" and "analog" easily. (See page 46 for details.)

NOTE: When connecting an audio/video unit to both of the digital and analog jacks of this unit, make sure to connect to both jacks of the same name.

NOTE: Be sure to attach the covers when the OPTICAL jacks are not being used, in order to protect the jacks from dust.

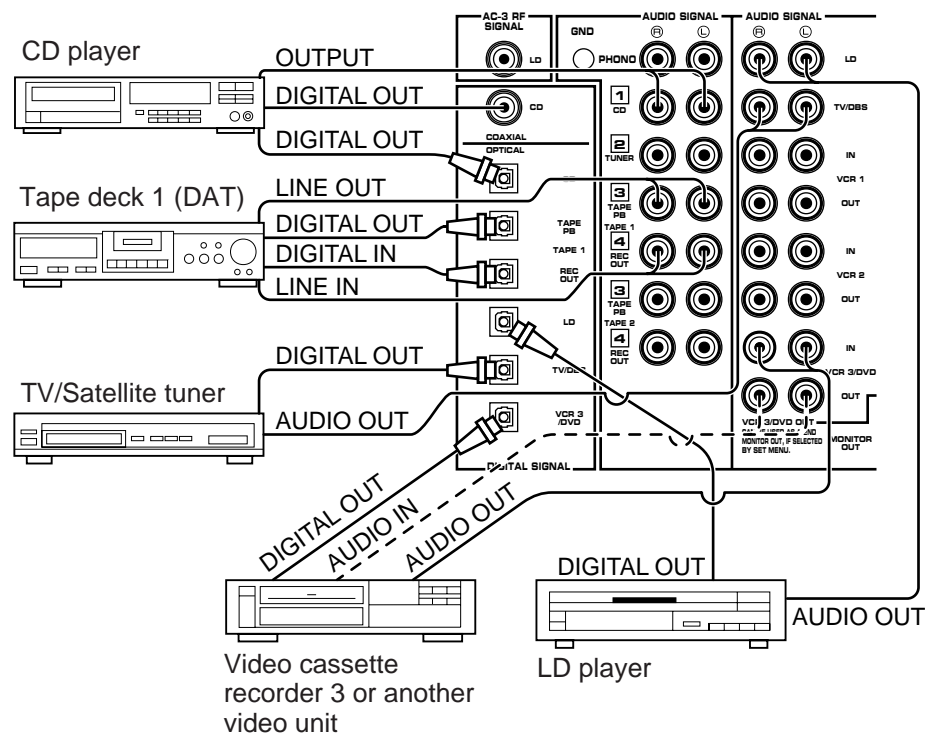

NOTE: All digital audio signal input jacks are applicable to the sampling frequency of 32 kHz, 44.1 kHz and 48 kHz.

CONNECTING TO AC-3 RF OUTPUT OF THE LD PLAYER

If your LD player has an AC-3 RF signal output jack, connect it to this unit's AC-3 RF SIGNAL input jack. Audio signals encoded with the Dolby Surround AC-3 are input to this unit by this connection.

- * To play back an LD source decoding its AC-3 RF signal, set the input mode of LD player to "AUTO" or "AC-3 RF". (See page 46 for details.)

It is also necessary to connect the LD player to this unit's OPTICAL digital audio signal input jack and/or analog audio signal input jacks regardless of the AC-3 RF signal connection, for playing back an LD source with the Dolby Pro Logic Surround decoded or in normal stereo (or monaural).

NOTE: AC-3 RF audio input signal cannot be recorded by a tape deck or VCR. To record an LD source, the LD player must be connected to the OPTICAL digital audio signal input jack and/or analog audio signal input jacks of this unit.

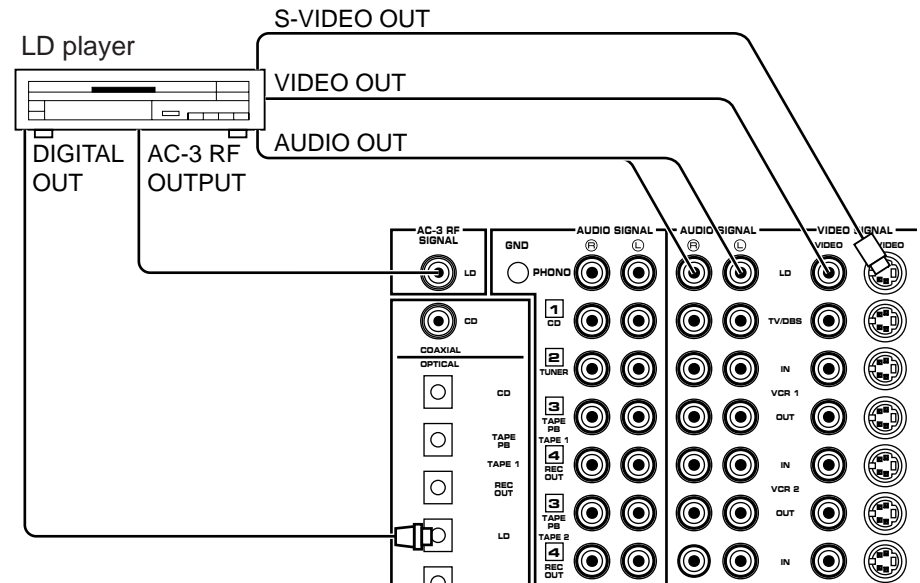

CONNECTING TO S VIDEO JACKS

If your video cassette recorder, LD player, etc. and your monitor are equipped with “S” (high-resolution) video terminals, connect them to this unit’s S VIDEO jacks, and connect this unit’s S VIDEO MONITOR OUT jack to the “S” video input of your monitor. Otherwise, connect the composite video jacks from your video cassette recorder, LD player, etc. to the VIDEO jacks of this unit, and connect this unit’s VIDEO MONITOR OUT jack to the composite video input of your monitor.

NOTE: If video signals are sent to both S VIDEO input and VIDEO input jacks, the signals will be sent to their respective output jacks independently.

NOTE: If your unit is the General Model, be sure the NTSC/PAL switch has been correctly set to the standard that your video equipment employs. U.S.A. and Canada models have no switch and use the NTSC standard, while other models without a switch use the PAL standard.

Notes about the Video superimpose

- If you watch a video source that is connected to both S VIDEO and VIDEO input jacks of this unit, signals of screen display information are output from only the S VIDEO MONITOR OUT jack.
 - When no video signal is input to either S VIDEO or VIDEO input jacks of this unit, signals of screen display information are output from both S VIDEO MONITOR OUT and VIDEO MONITOR OUT jacks with a color background.
- * For the General Model, if the NTSC/PAL switch on the rear panel is set to “PAL”, nothing will be output from either S VIDEO MONITOR OUT or VIDEO MONITOR OUT jack in this case.

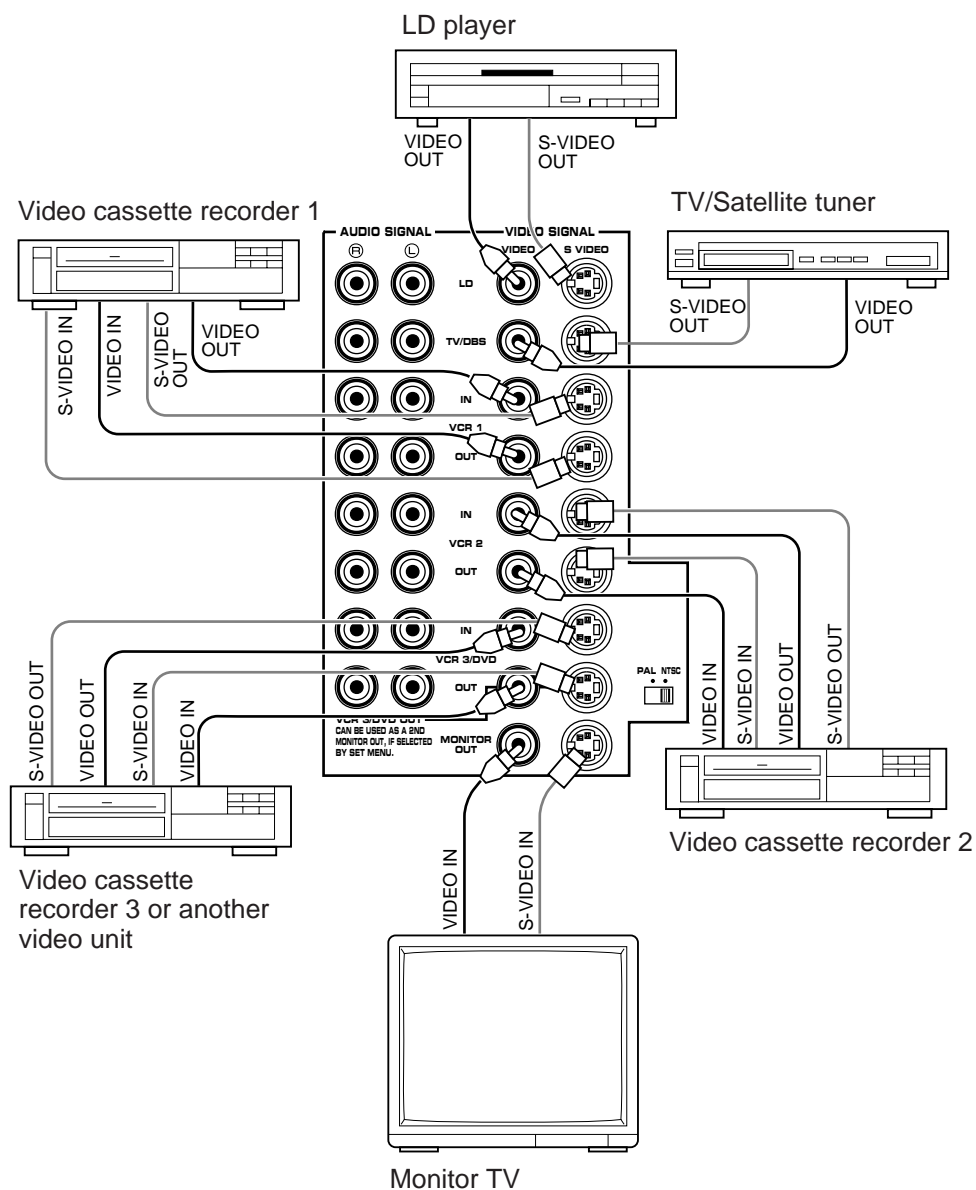

For connecting with a monitor TV that uses a 21 pin connector for input (for Europe and U.K. models)

Make a connection as figured below with a commercially available scart-plug connector cable.

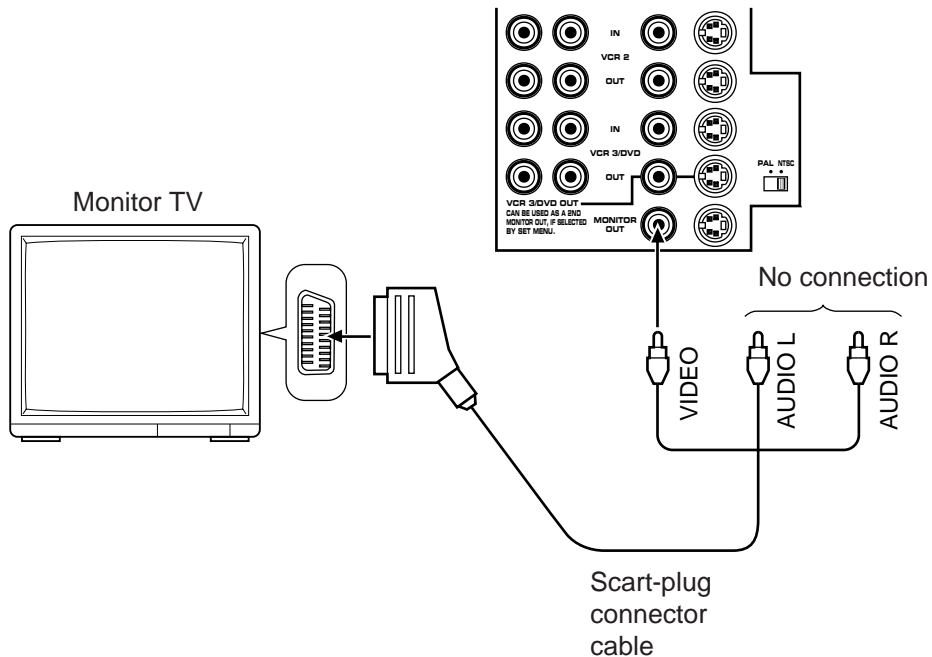

CONNECTING SPEAKER SYSTEMS

Connect the SPEAKERS terminals to your speakers with wire of the proper gauge, cut as short as possible. If the connections are faulty, no sound will be heard from the speakers. Make sure that the polarity of the speaker wires is correct, that is, + and – markings are observed. If these wires are reversed, the sound will be unnatural and will lack bass. Do not let the bare speaker wires touch each other or any other metal part as this could damage this unit and/or speakers.

NOTE: Use speakers with the specified impedance shown on the rear of this unit.

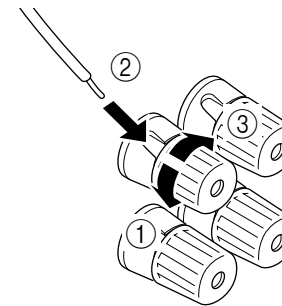

Red: positive (+)
Black: negative (-)

- ① Unscrew the knob.
- ② Insert the bare wire.

[Remove approx. 5mm (1/4") insulation from the speaker wires.]

- ③ Tighten the knob and secure the wire.

NOTE: Banana Plug connections are also possible (U.S.A., Canada, Australia and General models only). Simply insert the Banana Plug connector into the corresponding terminal.

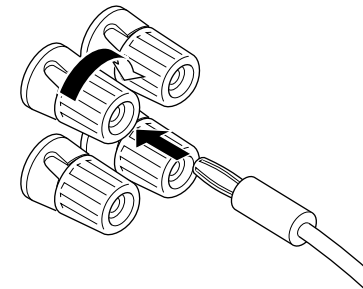

CONNECTING THE MAIN SPEAKERS TO THIS UNIT

Connect the MAIN speakers to the MAIN SPEAKERS terminals of this unit. Make sure that the jumper bars between the PRE OUT and MAIN IN jacks on the rear panel are in place. It is also possible to use an external power amplifier if more power is desired. In this case, remove the jumper bars and connect the PRE OUT jacks to the INPUT jacks of a stereo power amplifier with a stereo pin cable—making sure to connect the left and right channels correctly. Connect the MAIN speakers to the speaker output terminals of the power amplifier.

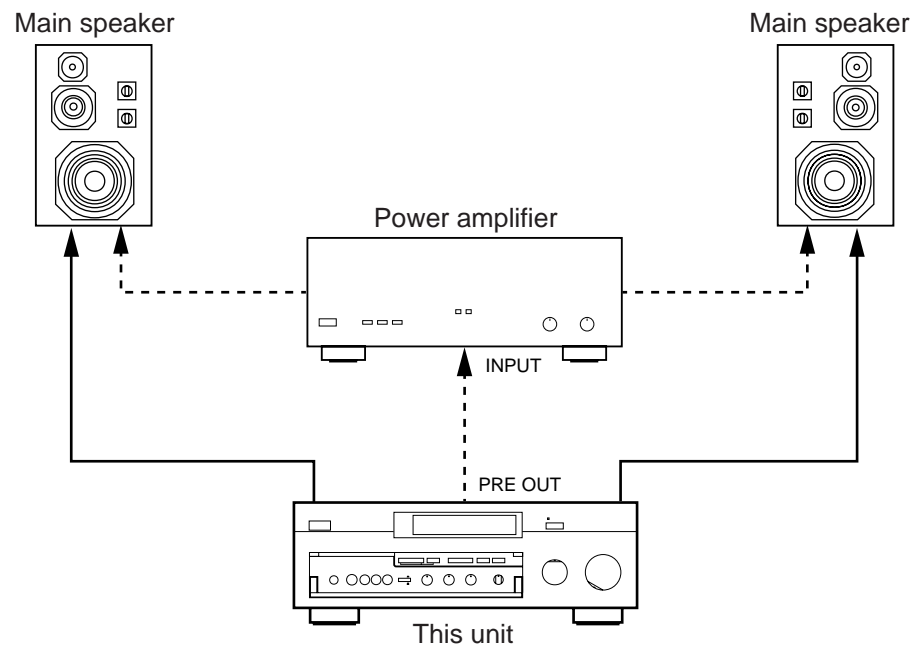

CONNECTING THE EFFECT SPEAKERS AND THE CENTER SPEAKER(S) TO THIS UNIT

Connect the FRONT effect speakers to the FRONT SPEAKERS terminals of this unit.

If the FRONT effect speakers are not used, the FRONT MIX switch should be set to "ON".

Connect the REAR effect speakers to the REAR SPEAKERS terminals of this unit.

Connect the CENTER speaker to the CENTER SPEAKERS terminals. If you will be using one CENTER speaker, connect it to either the A or B terminals and set the CENTER speaker impedance switch to "A OR B" (bottom position). If using two CENTER speakers, connect them to the A and B terminals, and set the switch to "A + B" (top position). If, however, you will not be using a CENTER speaker, be sure to set the CENTER SP mode to "PHNTM" (phantom). (See page 30.)

NOTE: The speaker connections above are fine for most applications. If for some reason, however, you wish to use an external power amp for any or all of the effect and center channels, connect the line level output jack(s) for each channel to the INPUT jacks of the external amp and connect the corresponding speaker pair to the speaker terminals of the external amp.

NOTE: If the pin plug is inserted in the FRONT/REAR EFFECT jacks, the speaker output from the built-in amplifier will be cut off.

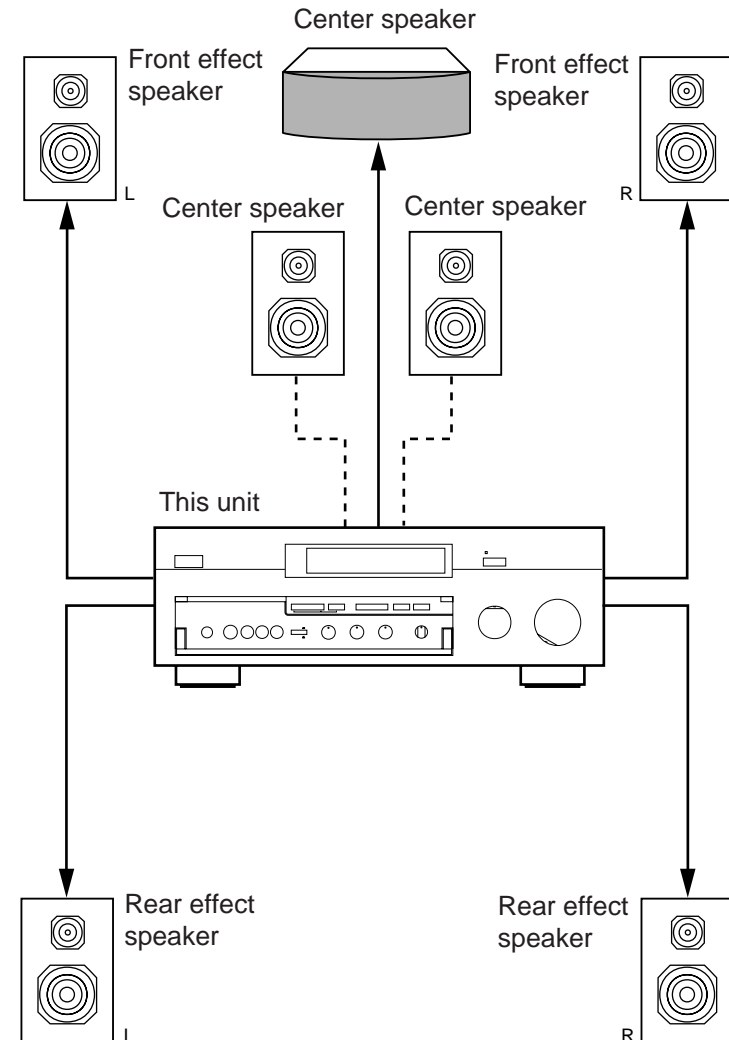

ADDING A SUBWOOFER

You may wish to add a subwoofer to reinforce the bass frequencies.

This unit provides line-level subwoofer outputs. If you use one subwoofer, connect the MONO SUBWOOFER jack to the INPUT jack of the subwoofer amplifier, and connect the speaker terminals of the subwoofer amplifier to the subwoofer.

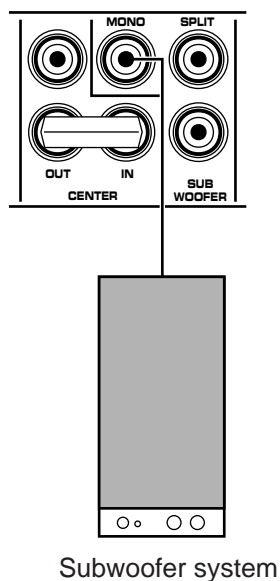

If you wish to obtain more presence in your listening room, the use of two subwoofers is recommended. To connect two subwoofers to this unit, connect the “left” SPLIT SUBWOOFER jack to the INPUT jack of the amplifier driving the left subwoofer, and the “right” SPLIT SUBWOOFER jack to the INPUT jack of the amplifier driving the right subwoofer, and then connect each subwoofer to the corresponding amplifier.

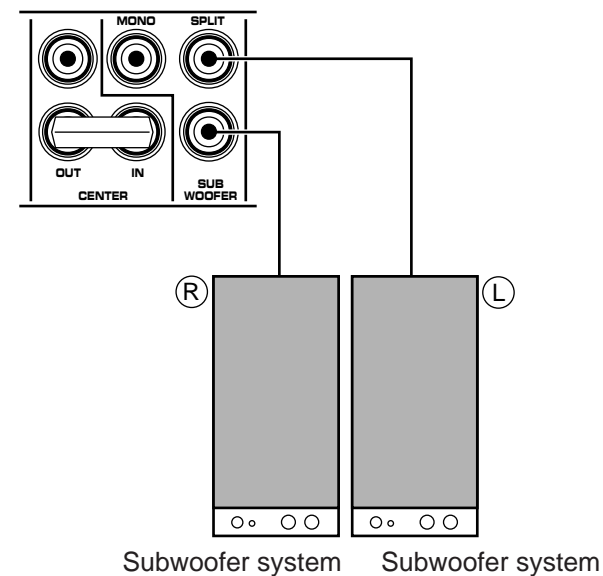

With some subwoofers, including the Yamaha Active Servo Processing Subwoofer System, the amplifier and subwoofer are in the same unit.

SELECTING THE OUTPUT MODES SUITABLE FOR YOUR SPEAKER SYSTEM

This unit provides you the following four functions to determine the method of distributing output signals to speakers suitable for your audio system. When speaker connections are all completed, select a proper position on each function to make the best use of your speaker system.

1. SPEAKER SET

1A. CENTER SPEAKER(S)

1B. REAR SPEAKERS *

1C. MAIN SPEAKERS *

1D. LFE/BASS OUT *

Note

Functions with "*" are provided only for better sound reproduction with the Dolby Surround AC-3 decoding.

DESCRIPTION OF EACH FUNCTION

1A. CENTER SPEAKER(S)

Choices: NRML/WD/PHNTM

Preset position: NRML

NRML: Select this position when you use a center speaker that is smaller than the main speakers. In this position, low bass signals (below 90 Hz) at the center channel are output from the main speakers (or the SUBWOOFER jacks if the SW or BOTH position is selected on "1D. LFE/BASS OUT").

WD: Select this position when your center speaker is approximately the same size as the main speakers.

PHNTM (Phantom):

Select this position when you do not have a center speaker. The center channel sound will be output from the left and right main speakers.

1B. REAR SPEAKERS

Choices: SMALL/LARGE

Preset position: SMALL

SMALL:

Select this position if your rear effect speakers do not have a high ability for bass reproduction.

In this position, low bass signals (below 90 Hz) at the rear surround channels are output from the main speakers (or the SUBWOOFER jacks if the SW or BOTH position is selected on "1D. LFE/BASS OUT").

LARGE:

Select this position if your rear effect speakers have a high ability for bass reproduction, or a subwoofer is connected to the rear effect speaker in parallel.

In this position, full range signals are output from the rear effect speakers.

1C. MAIN SPEAKERS**Choices: SMALL/LARGE****Preset position: LARGE****SMALL:**

Select this position if your main speakers do not have a high ability for bass reproduction. However, if your system does not include a subwoofer, do not select this position. In this position, low bass signals (below 90 Hz) at the main channels are output from the SUBWOOFER jacks (if the SW or BOTH position is selected on “1D. LFE/BASS OUT”).

LARGE:

Select this position if your main speakers have a high ability for bass reproduction. In this position, full range signals present at the main channels are output from the main speakers.

1D. LFE/BASS OUT**Choices: MAIN/SW/BOTH****Preset position: SW**

MAIN: Select this position if your system does not include a subwoofer.

In this position, full range signals present at the main channels, signals from the LFE channel and other low bass signals that are selected on 1A to 1C to be distributed from other channels are output from the main speakers.

SW/BOTH:

Select either the SW or BOTH position if your system includes a subwoofer.

In either position, signals at LFE channel and other low bass signals that are selected on 1A to 1C to be distributed from other channels are output from the SUBWOOFER jacks.

When the LARGE position is selected on “1C. MAIN SPEAKERS”, in the **SW** position, no signal is distributed from the main channels to the SUBWOOFER jacks, however in the **BOTH** position, low bass signals from the main channels are output to both of the main speakers and the SUBWOOFER jacks.

METHOD OF CHANGING SELECTIONS

The use of the remote control unit is recommended for simple operation. Operations should be made watching information on this unit's display panel or the monitor screen.

1. Turn the power of this unit on. (If you want to display information on the monitor, turn the power of the monitor on.)

Front panel

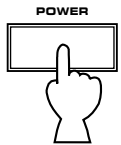

or

Remote control



2. Set the PARAMETER/SET MENU switch to the SET MENU position on the remote control unit.

Remote control

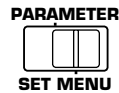

3. Press ∇ once so that "1. SPEAKER SET" lights up on the display.

Remote control

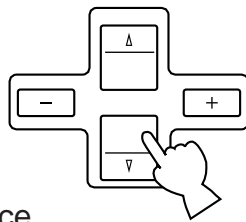

4. Press "+" or "-" once.

Remote control

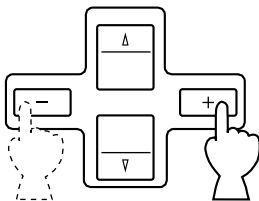

5. Press ∇ (or \triangle) once or more until the title of function on which you will change the selection appears on the display.

Remote control

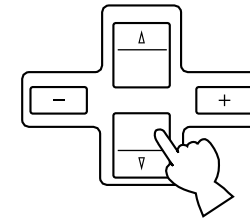

6. Press "+" or "-" once or more so that the arrow points the position you will select.

Remote control

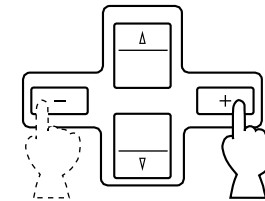

7. Repeat step 5 and 6 to change selections on other functions in the same way.

NOTE: The same operations can also be made on the front panel. First press the SET MENU switch and then INPUT TRIM control. Select the title of function by pressing the SET MENU switch, and change the choice by pressing the INPUT TRIM control.

ADJUSTMENTS BEFORE OPERATION

MAIN/CENTER/EFFECT SPEAKER LEVEL BALANCE ADJUSTMENT

This operation uses an internal test-tone generator for balancing the levels of the main, center and effect speakers.

1. Depress the TEST switch on the remote control so that “TEST DOLBY SUR.” appears on the display panel to enter test mode. A hiss-like calibration signal should be heard from the left main speaker, center speaker(s), right main speaker, right rear effect speaker and left rear effect speaker in turn (see diagram). Adjust the master VOLUME to a normal listening level.

* The state of test-tone output is shown by the display panel and the monitor screen. (On the monitor screen, it is shown by an image of audio listening room.) This is convenient for adjusting each speaker level.

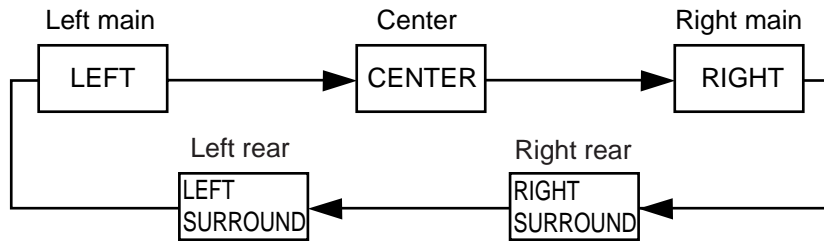

2. Adjust the center and rear level by using the CENTER and REAR LEVEL +/- keys on the remote control so that the sound coming from the corresponding speaker seems to be at the same level as that from the main speakers when you are at a normal listening position. The REAR LEVEL +/- keys adjust the right rear level if pressed while the test-tone is output from the right rear effect speaker, and adjust the left rear level if pressed while the test-tone is output from the left rear effect speaker. If the REAR LEVEL + or - key is pressed while the test-tone is output from other than the right or left rear effect speaker, the key adjusts either the right or left rear level that has been adjusted last time.

- * If there is insufficient volume from the effect speakers, you may decrease the main speaker volume level by setting the MAIN LEVEL switch on the rear panel to “-10 dB”, and adjust the center and rear level again. Volume controls on external power amplifiers may also be adjusted if necessary to achieve proper balance.
- * Pressing the Parameter + or - key (only when the PARAMETER/SET MENU switch is set to the PARAMETER position) transfers the test-tone from the speaker that is currently outputting the test-tone to the right or left rear effect speaker. Pressing “+” transfers the test-tone to the right rear effect speaker, and “-” to the left rear effect speaker.
- * Pressing and holding the Parameter Select ▽ or △ key (only when the PARAMETER/SET MENU switch is set to the PARAMETER position) fixes the test-tone on the speaker that is currently outputting the test-tone.

NOTE: If not using a center speaker, be sure to set the CENTER SP mode to the PHNTM (phantom) position. You will then hear the center channel test tone from the left and right main speakers.

3. For the front effect speaker level adjustment, depress the TEST switch on the remote control again so that “TEST DSP” appears on the display panel. A calibration signal should be heard from the main speakers and the front effect speakers in turn (see diagram).

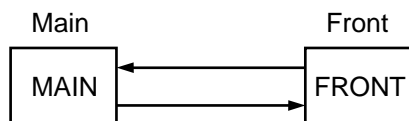

- * Pressing the parameter + or – key (only when the PARAMETER/SET MENU switch is set to the PARAMETER position) transfers the test-tone from the speaker that is currently outputting the test-tone to the front effect speakers. Pressing “+” transfers the test-tone to the right front effect speaker, and “–” to the left front effect speaker.
 - * Pressing and holding the parameter select ▽ or △ key (only when the PARAMETER/SET MENU switch is set to the PARAMETER position) fixes the test-tone on the speaker that is currently outputting the test-tone.
4. Adjust the front level by using the FRONT LEVEL +/- keys on the remote control so that the speaker volume is the same as that of the main speakers.

When this adjustment is finished, press the TEST switch once again.

NOTE: Once you have completed these adjustments, use only VOLUME control of this unit or MASTER VOLUME keys of the remote control unit to adjust the whole listening volume. Do not change any other volume setting in the system.

INPUT LEVEL ADJUSTMENT

This adjustment is important for obtaining the best performance from the internal circuits of this unit. The optimum input level of this unit is pre-adjusted on the basis of the CD source level. This adjustment should be performed on all input sources in your system respectively, so that their levels match the CD source level as closely as possible.

1. Select the CD source.

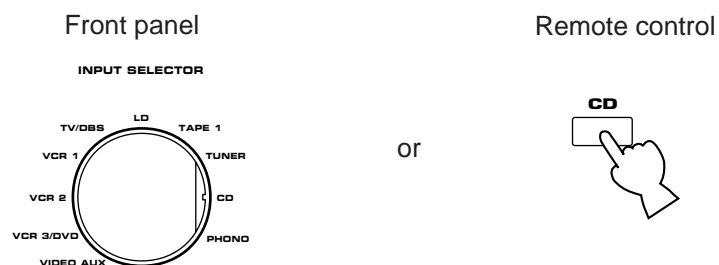

2. Play the source.

3. Increase the setting of the master VOLUME control to a convenient listening level (you will use this as your "reference" level).

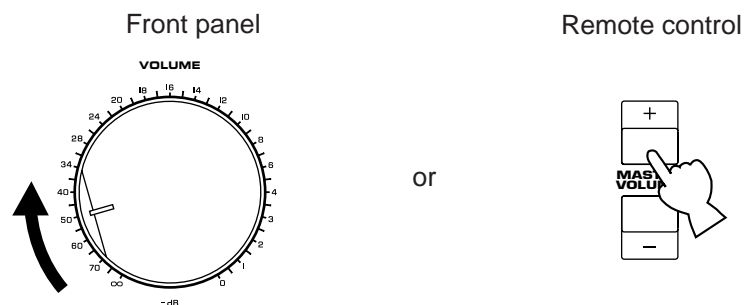

4. Select any other source in your system (VCR, tuner, etc.) and play that source.

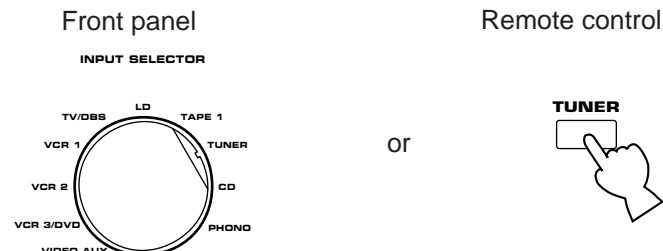

5. Adjust the level of the source to be approximately equal to your CD player's "reference" level by using the INPUT TRIM control.

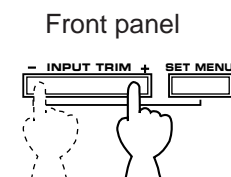

- * This adjustment can also be done with the remote control unit. For using the remote control unit, refer to "11. INPUT TRIM (Input level adjustment)" on page 44.

6. In the same way, adjust levels of other sources.

NOTES

- The adjustments will be saved until it is readjusted.
- When the Dolby Surround AC-3 is decoded, your adjustment will become ineffective, and the preset input level is restored.

ADJUSTMENTS IN THE “SET MENU” MODE

The following thirteen types of functions maximize the performance of your system and expand your enjoyment for audio listening and video watching.

1. **SPEAKER SET**
2. **LOW FREQ. TEST**
3. **LFE LEVEL**
4. **CENTER DELAY**
5. **CENTER GEQ**
6. **CINEMA EQ**
7. **DYNAMIC RANGE**
8. **PARAMETER INI**
9. **MEMORY GUARD**
10. **VCR3 VIDEO**
11. **INPUT TRIM**
12. **INPUT MODE**
13. **DIMMER**

METHOD OF SETTING CHANGE AND ADJUSTMENT

The use of the remote control unit is recommended for simple operation. Operations should be made watching information on this unit's display panel or the monitor screen. If you want to display information on the monitor, turn the power of the monitor on.

1. Set the PARAMETER/SET MENU switch to the SET MENU position on the remote control unit.

Remote control

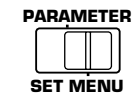

2. Select the function (title) on which you will make a change.

Remote control

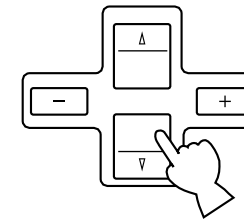

3. Select any desired position or edit parameters on the function.

Remote control

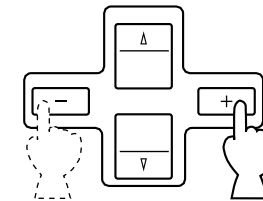

In the same way, make a setting change or adjustment on any other function.

DESCRIPTIONS OF THE FUNCTIONS

1. SPEAKER SET (Selecting the output modes suitable for your speaker system)

See page 30 for details. (Once you have selected proper modes, you do not have to make a setting change until any alteration is made in your speaker system.)

2. LOW FREQ. TEST (Adjusting subwoofer level by using the test-tone)

The internal low frequency test-tone generator is useful for adjusting subwoofer level to make the subwoofer sound match the sound of other speakers in your audio system.

Operating procedure

1. After selecting this function (title) in step 2 on page 36, press the Parameter + or – key to display the mode for adjustment.
2. Press the Parameter Select (▽) key so that the arrow points to “TEST TONE OFF”. Next press the Parameter + or – key to switch to the “ON” position.
The test-tone is heard from the selected speaker(s).

3. Press the Parameter Select (▽) key so that the arrow points to “OUTPUT”. Next press the Parameter + or – key to select the speaker whose sound you want to compare with the subwoofer sound. The test-tone is output from the selected speaker.

- * Adjust the Master VOLUME control so that the test tone can be heard at your desired listening level.
- * If “SUBWOOFER” is selected, the test-tone below 90 Hz is output from the subwoofer.
- * The test-tone will not be necessarily output from the selected speaker(s) only. The output mode of the test-tone depends on the settings on “1. SPEAKER SET” in the SET MENU mode.
- * Even if during source play, the test tone is output instead of the source sounds.

4. Press the Parameter Select (▽) key so that the arrow points to “FREQ. 35 Hz”. To confirm that the subwoofer sound matches the sound of other speakers, change the frequency of test-tone one by one by pressing the Parameter + or – key. (Frequency can be changed from 35 Hz to 250 Hz, and last, all range (35–250 Hz) of frequencies are output.)

Adjust subwoofer level with the control on the subwoofer so that the subwoofer sound matches the sound of other speakers in any range of low frequencies.

NOTE: This low frequency test-tone can also be applied to check the bass response in your room. For the best bass condition, bass sound must be heard definitely at any position in your room. If not so, change the setting of subwoofer or furniture in your room.

3. LFE LEVEL (Adjusting the output level at the LFE (low frequency effect) channel)

Control range: MUTE, –20 dB to 0 dB (in 1 dB step)

Preset value: 0 dB

- * This adjustment is effective only when the Dolby Surround AC-3 is decoded.

Adjusts the output level at the LFE (low frequency effect) channel. If the LFE signals are mixed with signals at the main channels to output them from the main speakers, only the level of the LFE signals are adjusted. When adjusted to MUTE, only the LFE sound will not be output. (See page 6 for details about the LFE channel.)

4. CENTER DELAY (Adjusting the delay of center sounds (dialog etc.))

Control range: 0 ms to 5 ms (in 1 ms step)

Preset value: 0 ms

Adjusts the delay between the main sounds (at the main channels) and dialog etc. (at the center channel).

The larger the value, the later the dialog etc. is generated.

This is for making sounds from the left main, center and right main speakers reach your listening position at the same time by delaying the sound from the center speaker if the distance from the center speaker to your listening position is shorter than the distance from the left or right main speaker to your listening position.

5. CENTER GEQ (Adjusting the Center Channel Graphic Equalizer)

The built-in five band graphic equalizer is used to tailor, over a ± 6 dB range, the overall output frequency response of the center channel. The five bands cover the complete audible sound spectrum and are centered on 100 Hz, 300 Hz, 1 kHz, 3 kHz and 10 kHz frequencies. Adjustment should be done to each frequency individually.

Adjusting method

After selecting the function (title) in step 2 on page 36, press the Parameter + or – key on the remote control to display the condition of the equalizer. Then select a frequency with the Parameter Select keys on the remote control and adjust its level with the Parameter +/- keys.

- * Adjustment can be made by monitoring sounds using the test-tone. To use the test-tone, press the TEST switch so that “TEST DOLBY SUR.” appears on the display before making adjustment. The test-tone is output from the center speaker(s).

6. CINEMA EQ (Adjusting the tonal balance of speakers)

It is difficult to balance tonal quality of the main, center, front effect and rear effect speakers, because they may be different in type and size, and their setting positions and heights are also different. The built-in CINEMA Equalizer enables you to balance tonal quality of the speakers easily by adjusting tonal quality of the main/center, front effect and rear effect channels individually.

This is also useful to compensate for loss of tonal response of the main and center speakers when those speakers are placed behind the projection screen (if you use a projector in place of a TV).

The CINEMA Equalizer consists of the High-shelving equalizer (HIGH) and the Parametric equalizer (PEQ). The High-shelving equalizer changes high frequency characteristics smoothly, and the Parametric equalizer boosts or cuts any selected frequency smoothly.

Adjusting method

- After selecting this function (title) in step 2 on page 36, press the Parameter + or – key on the remote control.
- Select the channels on which you will make adjustments by pressing the Parameter Select ▽ or △ key so that the arrow points the corresponding title.
 - L, C, R** Left main, center and right main channels
 - FRONT EFCT** Front effect channels
 - REAR EFCT** Rear effect channels
- Press the Parameter + or – key to turn the equalizer for the selected channels to “ON”.

- Press the Parameter Select ▽ key repeatedly until the title of adjusting mode (**6A. L,C,R EQ/6B. FRONT EFCT EQ/6C. REAR EFCT EQ**) for the channels on which you will make adjustments is displayed.

* The adjusting mode will not be displayed for the channels that are set to “OFF” in step 2.

- Make adjustments for the selected channels. Select the item with the Parameter Select ▽ or △ key and change the value with the Parameter + or – key.

HIGH: FRQ Selects a turnover frequency of the High-shelving equalizer.

GAIN Adjusts the maximum equalizing level.

PEQ: FRQ Selects a frequency you will boost or cut.

GAIN Adjusts the equalizing level on the selected frequency.

- * Adjustment can be made by monitoring sounds using the test-tone. To use the test-tone, press the TEST switch so that “TEST DOLBY SUR.” or “TEST DSP” appears on the display. The test-tone is fixed on the channels on which you make an adjustment and output from the corresponding speakers.

It is recommended to make these adjustments together with the tonal quality adjustment of the center speaker on the function “5. CENTER GEQ”.

NOTE: Excessive increase of the GAIN level may cause an overload. It is recommended to adjust the GAIN level so that it becomes lower than the preset value.

■ Preset value of the CINEMA Equalizer

L, C, R EQ

HIGH: FRQ 12.7 kHz **PEQ: FRQ** 12.7 kHz
GAIN -3 dB **GAIN** -4 dB

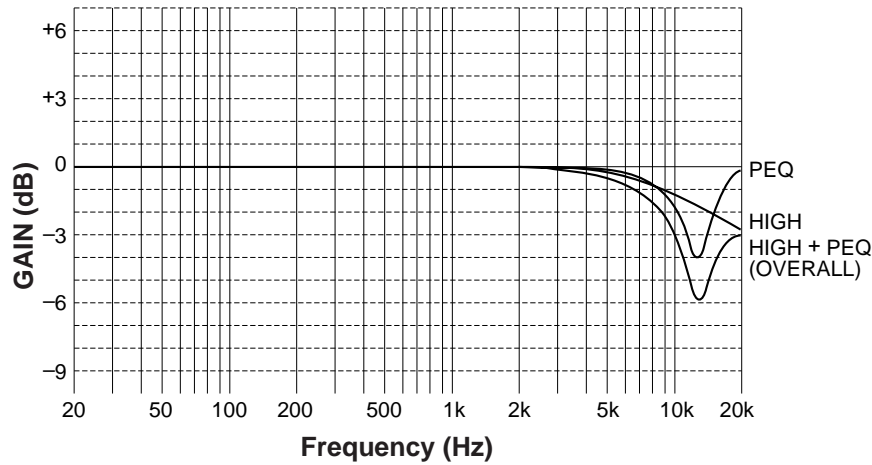

FRONT, REAR EFCT EQ

HIGH: FRQ 12.7 kHz **PEQ: FRQ** 8.0 kHz
GAIN 0 dB **GAIN** -3 dB

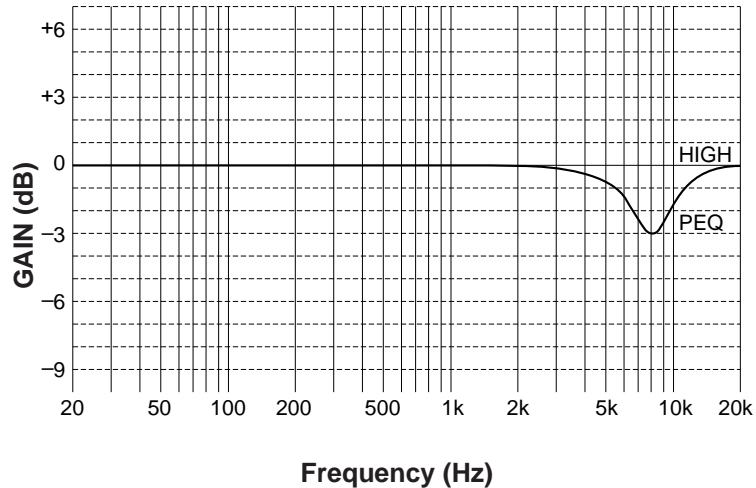

■ Frequency characteristics

The following curves show frequency characteristics when the High-shelving equalizer (HIGH) is adjusted at the indicated values.

HIGH: FRQ 1.0 kHz
GAIN +6 dB to -9 dB

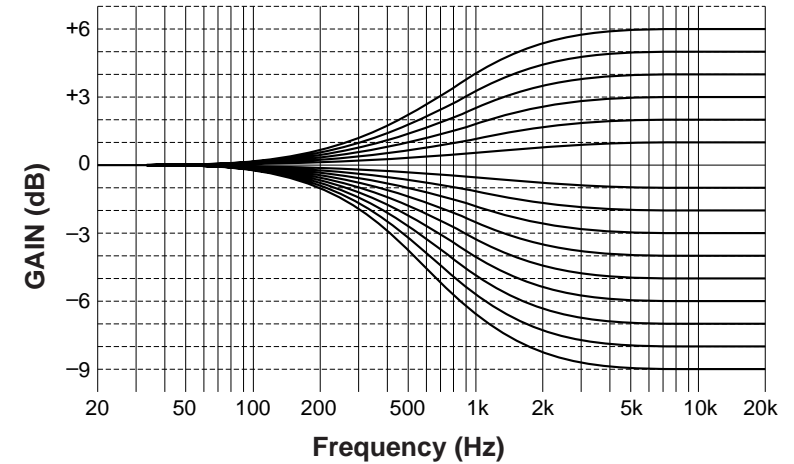

HIGH: FRQ 1.0 kHz to 12.7 kHz
GAIN +6 dB/-9 dB

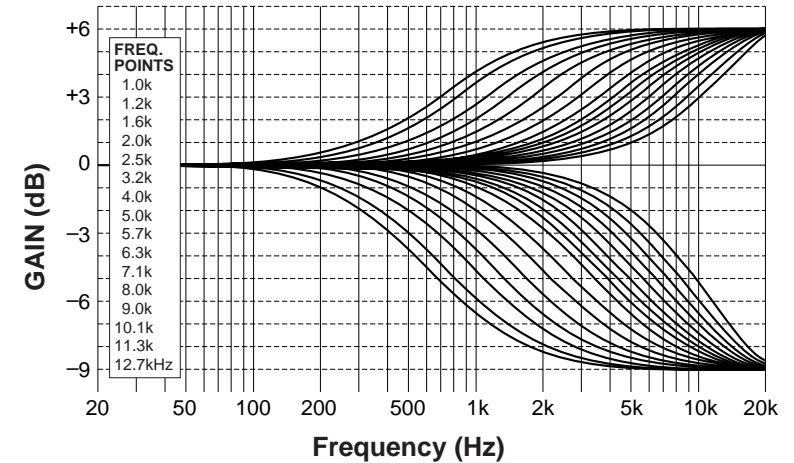

The following curves show frequency characteristics when the Parametric Equalizer (PEQ) is adjusted at the indicated values.

PEQ: FRQ 1.0 kHz
GAIN +6 dB to -9 dB

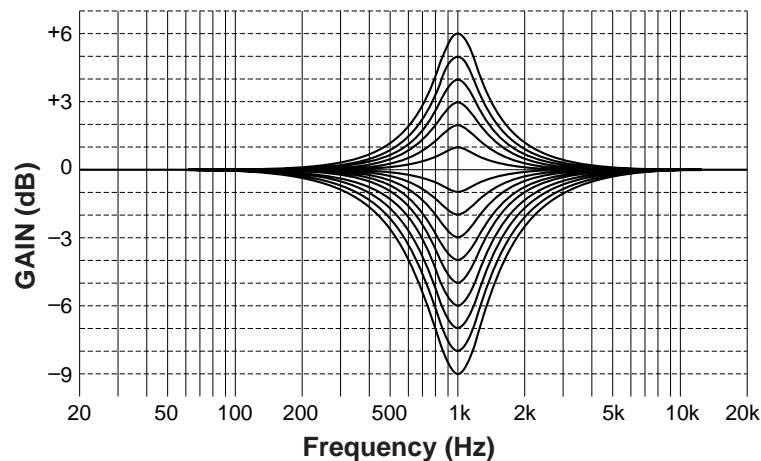

PEQ: FRQ 1.0 kHz to 12.7 kHz
GAIN +6 dB/-9 dB

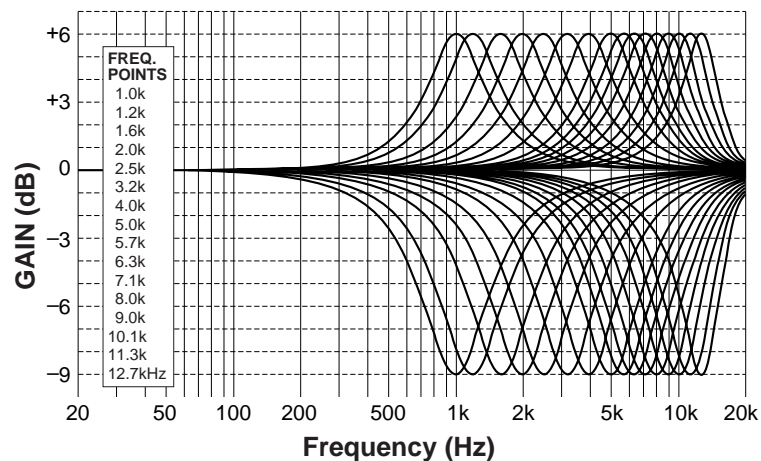

7. DYNAMIC RANGE (Adjusting dynamic range)

Choices: MAX/STD/MIN

Preset position: MAX

- * This adjustment is effective only when the Dolby Surround AC-3 is decoded.

After selecting this function (title) in step 2 on page 36, press the Parameter + or - key to display the choices MAX, STD and MIN.

MAX: "Dynamic range" is the difference between the maximum level and the minimum level of sounds. Sounds on a movie originally designed for movie theaters feature very wide dynamic range.

AC-3 technology can bring the original sound track into a home audio format with this wide dynamic range unchanged.

In this position, an AC-3 source is reproduced in the original sound track's wide dynamic range providing you with powerful sounds like a movie theater.

Selecting this position will be more ideal if you can listen to a source in a high output level in a room specially soundproofed for audio/video enjoyment.

STD (Standard):

Powerful sounds of extremely wide dynamic range are not always suitable for home use. Depending upon the condition of your listening environment, it may not be possible to increase the sound output level as high as a movie theater, however, in a level proper for listening to in your room, the low level parts of source sound cannot be heard as well because they will be lost among noises in your environment.

AC-3 technology also makes it possible to reduce an original sound track's dynamic range for a home audio format by "compressing" the data.

In this position, an AC-3 source is reproduced in the "compressed" dynamic range of the source suitable for low level listening.

If you desire, you can adjust the dynamic range manually only when the STD position is selected.

■ H-LEVEL CUT (High Level Cut Scale)

Control range: 0.0 to 1.0 (in 0.2 step)

Preset value: 1.0

Adjusts the dynamic range of high level signals of source. The larger the value, the range is more reduced. The smaller the value, the range is more widened.

■ L-LEVEL BST (Low Level Boost Scale)

Control range: 0.0 to 1.0 (in 0.2 step)

Preset value: 1.0

Adjusts the dynamic range of low level signals of source. The larger the value, the range is more widened. The smaller the value, the range is more reduced.

Adjusting method

Select the title H-LEVEL CUT or L-LEVEL BST by pressing the Parameter Select ▽ or △ key and adjust its value by pressing the Parameter + or – key.

MIN: In this position, dynamic range is more reduced than in the STD position. Selecting this position will be effective when you must listen to a source in extremely low level.

* In this position, it may happen that sound is output faintly or not output normally depending on a source. In that case, select the MAX or STD position.

8. PARAMETER INI (Initializing parameters on a DSP program)

You can initialize all parameter settings on a DSP program. Note that a DSP program has two sub-programs; all parameters on both sub-programs are initialized by this operation.

Initializing method

After selecting this function (title) in step 2 on page 36, press the Parameter + or – key to display the DSP program numbers (1 – 12). A program number whose parameters has been changed is marked with "★". Press a Program Select Key corresponding to the program number of which parameters you want to initialize. When initialized, the "★" mark will disappear.

9. MEMORY GUARD (Locking DSP parameters and other adjustments)

If you wish to prevent accidental alteration to DSP parameters or other adjustments on this unit, select "ON". In this position, they are locked and cannot be changed. The following functions on this unit can be locked by this operation.

- DSP parameters
- Other functions in the "SET MENU" mode
- ON SCREEN display key
- INPUT TRIM control
- FRONT, REAR and CENTER level +/- keys
- TEST switch

10. VCR 3 VIDEO (Switching the VCR 3/DVD VIDEO OUT jack to a second monitor out jack.)

If you wish to connect a second monitor TV (or a projector) to this unit, select "MONTR" position. The VCR 3/DVD VIDEO OUT jack (and S VIDEO jack also) is switched to a second monitor out jack, so you can connect this jack to the video input jack of another monitor TV.

NOTES

- Even in the "MONTR" position, the VCR 3/DVD VIDEO IN jack can be used as a normal video signal input jack and the VCR 3/DVD AUDIO SIGNAL IN/OUT jacks as normal audio input/output jacks.
- If using the VCR 3/DVD jacks for connecting a third video cassette recorder only, be sure to select "REC OUT" position. If the picture on the monitor is disturbed while the third video cassette recorder is functioning, "MONTR" position may be selected. If so, select "REC OUT" position.

11. INPUT TRIM (Input level adjustment)

This function is available to all input sources. Select an input source with the INPUT SELECTOR on the front panel or the input selector keys on the remote control unit. Input level can be controlled from 0 to +6 dB in 2 dB steps. The sound level of each input source should be the same as that of regular CDs.

Input level adjustment can also be made by pressing the INPUT TRIM control on the front panel. (See page 35.)

- * When the Dolby Surround AC-3 is decoded, your adjustment will become ineffective, and the preset input level is restored.

12. INPUT MODE (Selecting the initial input mode of the sources connected to the TV/DBS and VCR3/DVD input jacks)

For the sources connected to the TV/DBS and VCR3/DVD input jacks of this unit only, you can designate the input mode that is automatically selected when the power of this unit is switched on or when the input source is changed.

AUTO: In this position, the AUTO input mode is always selected when the power of this unit is switched on or when the input source is changed.

LAST: In this position, the input mode you have selected last time is memorized and will not be changed even if the power of this unit is switched on or when the input source is changed.

- * See page 46 for details about switching the input mode.

Operating method

After selecting this function (title) in step 2 on page 36, press the Parameter + or – key on the remote control. Next select the input source TV/DBS or VCR3/DVD by pressing the Parameter Select ▽ or △ key so that the arrow points to its name, and then select the AUTO or LAST mode by pressing the Parameter + or – key.

13. DIMMER (Changing brightness of the display panel)

You can adjust brightness of the display panel.

GENERAL OPERATION

PLAYING A SOURCE

1. Set the master VOLUME control to minimum.

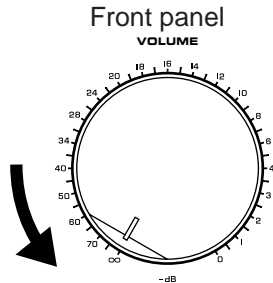

2. Turn the power on.

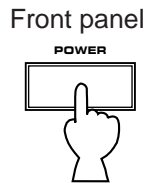

or

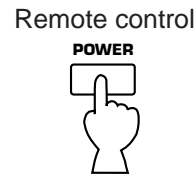

3. Select an input source.

The selected source is shown by the display panel and the monitor screen. For the source that inputs two or more types of signals to this unit, its current input mode is also shown.

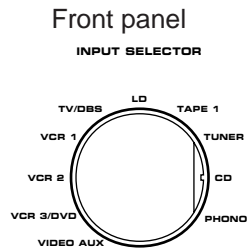

or

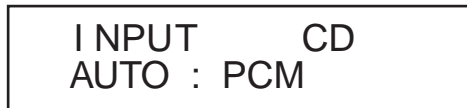
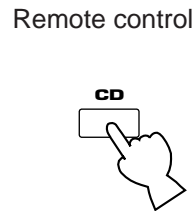

- * To change the input mode, press the INPUT MODE switch on the front panel or the input selector key for the currently selected source on the remote control unit. (See page 46 for details on switching the input mode.)

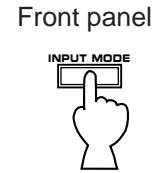

or

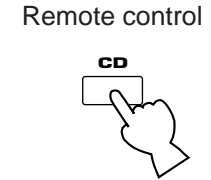

- * To select a tape deck connected to this unit's TAPE 2 jacks, press the TAPE 2 MONITOR switch. (Otherwise, turn this switch off.)

Front panel



4. Play the source.

5. Increase the setting of the master VOLUME control to your listening level.

Front panel

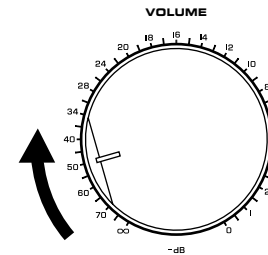

or

Remote control

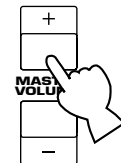

Adjust the BASS, TREBLE, BALANCE controls, etc., or select a desired sound field program. (See page 49.)

NOTE: If a different audio source is selected with the input selector keys on the remote control unit while enjoying a video source, the sound from the newly selected audio source is heard, but the picture from the video source can still be seen.

Switching the input mode

This unit allows you to switch the input mode only for sources that input two or more types of signals to this unit.

■ For CD, TAPE 1, TV/DBS and VCR3/DVD sources:

The following two input modes are provided.

AUTO:

This mode is automatically selected when you turn on the power of this unit or when you change input source. In this mode, input signal is automatically selected by the following order of priority.

1. Digital AC-3 input signal (**AC-3**)
or Normal digital input signal (**PCM**)
2. Analog input signal (**ANALOG**)

* For CD source, if digital signals are input from both of the OPTICAL and COAXIAL jacks, the digital signal from the OPTICAL jack is selected.

ANALOG:

In this mode, only analog input signal is selected even though digital signal is input at the same time. Select this mode when you want to use the analog input signal instead of the digital input signal.

■ For LD sources:

The following four input modes are provided.

AUTO:

This mode is automatically selected when you turn on the power of this unit or when you change input source. In this mode, input signal is automatically selected by the following order of priority.

1. AC-3 RF signal (**AC-3**)
2. Digital AC-3 input signal (**AC-3**)
or Normal digital input signal (**PCM**)
3. Analog input signal (**ANALOG**)

AC-3 RF:

In this mode, only AC-3 RF signal is selected.

DIGITAL:

In this mode, only digital input signal is selected even though other types of signals are input at the same time.

ANALOG:

In this mode, only analog input signal is selected even though other types of signals are input at the same time.

Notes on input mode selection for LD sources

- To play back a Dolby Surround AC-3 encoded source decoding its AC-3 RF signal, set the input mode to “AUTO” or “AC-3 RF”.
- When you want to enjoy a Dolby Surround AC-3 encoded source with a Dolby Pro Logic Surround program, select the DIGITAL or ANALOG mode.
- In the AUTO mode, there may be a case that when you stop the play of a Dolby Surround AC-3 encoded source temporarily by pressing the PAUSE button or making a chapter search on the LD player, the currently selected signal is changed to digital or analog signal automatically, and when the play is restored, the AC-3 RF signal is selected again. Sound output is interrupted for a moment when such a change of input signals occurs. To prevent an undesirable change of input signals, fix the AC-3 RF signal by selecting the AC-3 RF mode.

NOTES

- For sources PHONO, TUNER, TAPE 2, VCR 1 and VCR 2, the input mode cannot be changed because they input analog signals only to this unit.
- When the input source is changed to LD, CD, TAPE 1, TV/DBS or VCR3/DVD, or the input mode is changed, the currently selected input mode is shown on the display panel and the monitor screen. If changed to the AUTO mode, the type of selected input signal is also shown as figured below.

I NPUT	CD
AUTO	: PCM

- * However, if those operations are made when the test-tone is output from this unit, the type of selected input signal will not be shown. (Only “AUTO” will be displayed.)

RECORDING A SOURCE TO AUDIO/VIDEO TAPE (OR DUBBING FROM A TAPE TO ANOTHER)

1. Set the REC OUT selector to the SOURCE position.

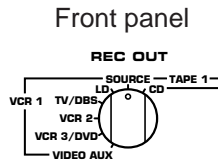

2. Select the source you want to record.

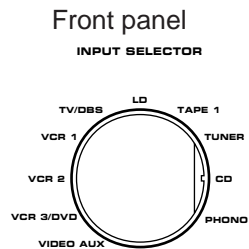

Remote control

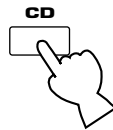

3. Play the source and increase the setting of the master VOLUME control to confirm it.

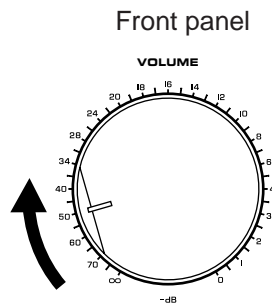

4. Set the tape deck or VCR used for recording to the recording mode.

Regardless of the setting of the INPUT SELECTOR, when you set the REC OUT selector to CD, the audio signal from your CD player can be recorded by your first tape deck. Likewise, when the REC OUT selector is set to LD, TV/DBS, VCR 2, VCR 3/DVD or VIDEO AUX, both the audio and video signals of the selected source can be recorded by your first VCR.

While recording a source by setting the REC OUT selector to the position other than SOURCE as described above, the following operations can be made at the same time.

- You can monitor the audio (or the audio and video) signals being recorded by selecting TAPE 1 (or VCR 1) on the INPUT SELECTOR.
- You can watch or listen to any other source by selecting it with the INPUT SELECTOR.
- You can use any other VCR or tape deck not selected by the REC OUT selector to record an audio and video source selected by the INPUT SELECTOR.

The audio and video signals from VCR 2 (or VCR 3) are sent to VCR 1 when the REC OUT selector is set to VCR 2 (or VCR 3).

If the REC OUT selector is set to VCR 2 (or VCR 3), you can not dub from your first VCR to the second VCR (or the third VCR), even if VCR 1 is selected by the INPUT SELECTOR.

To dub the audio from your second tape deck to the first one, depress the TAPE 2 MONITOR switch (and set the INPUT SELECTOR to any source other than TAPE 1 before beginning to record).

NOTE: Adjusting the master VOLUME, BASS, TREBLE controls, etc., or selecting a sound field program has no effect on the material being recorded.

NOTE: Composite video and S video signals pass independently through this unit's video circuits. Therefore, when recording or dubbing video signals between two video cassette recorders, if your source VCR is connected to provide only S video (or only composite video) signals, you can record only a S video (or only a composite video) signal on your second VCR.

NOTE: A source that is connected to this unit between digital jacks only cannot be recorded by a tape deck or VCR other than the tape deck connected to the OPTICAL TAPE 1 REC OUT jack of this unit.

NOTE: AC-3 RF audio input signal cannot be recorded by a tape deck or VCR. To record an LD source, the LD player must be connected to the OPTICAL digital audio signal input jack and/or analog audio signal input jacks of this unit.

NOTE: Please check the copyright laws in your country to record from records, compact discs, radio, etc. Recording of copyright material may infringe copyright laws.

If you watch a video software that uses scramble or encoded signals to prevent it from being dubbed, there may be a case that display information superimposed on the picture and/or the picture itself is disturbed due to those signals.

SELECTING SOUND FIELD PROGRAMS

This unit has 12 programs for digital sound field processing, 6 from actual acoustic environments from around the world, and 6 programs for Audio/Video sources including sources encoded with Dolby Pro Logic surround or Dolby Surround AC-3. Many of the programs contain various parameters that can be adjusted to the listener's taste.

1. Set the PARAMETER/SET MENU switch on the remote control to the PARAMETER position.

Remote control

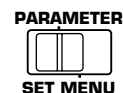

2. Select the desired sound field program by pressing the PROGRAM selector on the front panel or by using the Program Select keys on the remote control.

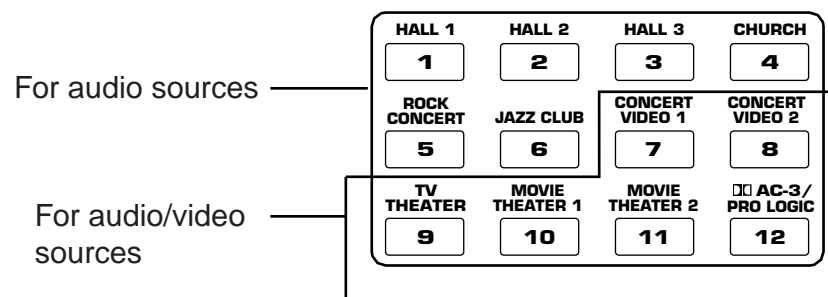

3. All sound field programs have two “sub-programs” (see “DESCRIPTIONS OF THE SOUND FIELD PROGRAMS”). The sub-programs are selected using the PROGRAM Selector on the front panel or the Parameter +/- keys on the remote control unit. The CONCERT HALL 1 program, for example, contains the sub-programs “Hall A in Europe” and “Hall B in Europe”. When the CONCERT HALL 1 program is first selected, the “Hall A in Europe” sub-program will be selected and displayed on the front panel. To select “Hall B in Europe”, press the Parameter + or – key. To return to Hall A in Europe, press the Parameter + or – key again. The same procedure applies to all other programs. The sub program selection can also be done simply by pressing the corresponding Program Select key on the remote control.

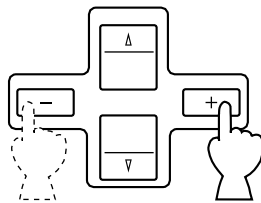

- * If you will change the sub-program by pressing a Program Select key while watching the monitor screen, press a key as described below;
If the display type is a full display, press the key of the corresponding program once. If the display type is a simple display or no display, press the key twice.



To enjoy a video source with the surround-sound effects of Dolby Pro Logic Surround or Dolby Surround AC-3

Select the program No. 10, No. 11 or No. 12 that suits your preference. Dolby Surround is decoded automatically distinguishing the input signal.

If the selected input signal is the AC-3 RF signal or digital AC-3 input signal, Dolby Surround AC-3 is decoded. If the selected input signal is another type of signal, Dolby Pro Logic Surround is decoded.

- * You can know which decoding is being made by watching on the front panel. When the Dolby Surround AC-3 is being decoded, “ AC-3” lights up, and when the Dolby Pro Logic Surround is being decoded, “ PRO LOGIC” lights up on the front panel. In addition, the name of the program (or sub-program) on the display panel or the monitor screen will change according to the type of decoding. (See pages 55–57 for details.)

NOTE: Make sure that the source you will play is encoded with Dolby Surround. Dolby Surround will not be decoded to the source that is not encoded with Dolby Surround.

MUTING THE EFFECT SOUND

The EFFECT switch on the front panel and the EFFECT ON/OFF key on the remote control unit make it simple to compare the normal stereo sound with the fully processed effect sound.

To mute the effect sound and monitor only the main sound, press the EFFECT ON/OFF key or the EFFECT switch. Press the EFFECT ON/OFF key or the EFFECT switch a second time to restore normal operation.

Front panel



or

Remote control

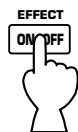

NOTES

- If the EFFECT switch or the EFFECT ON/OFF key is pressed to turn effect sounds OFF when Dolby Surround AC-3 is decoded, the sampling frequency and channel formation of the decoded signal is shown on the display panel.

ex.)



Sampling frequency is
44.1 kHz.

Three channels at the front
Two channels at the rear

- If the EFFECT switch or the EFFECT ON/OFF key is pressed to turn effect sounds OFF when Dolby Surround AC-3 is decoded, it may happen that sound is output faintly or not output normally depending on a source. In that case, press the EFFECT switch or the EFFECT ON/OFF key to turn effect sounds ON, or use an input signal other than the AC-3 RF signal.

SUPERIMPOSED VIDEO PROGRAM/PARAMETER DISPLAY

You can select program names and edit parameters watching their data displayed on your video monitor screen and superimposed over the video image as described on page 9.

- Turn your monitor on, and press the ON SCREEN display key on the remote control unit to call the full display mode.

Remote control



- The current program name and its parameters will be displayed on the monitor screen. The arrow-shaped cursor points to the currently selected parameter. Parameters are selected and edited using the Parameter Select keys and +/- keys. (See page 59 for details.)

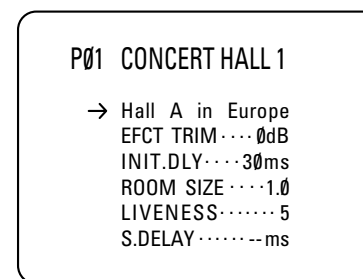

Remote control

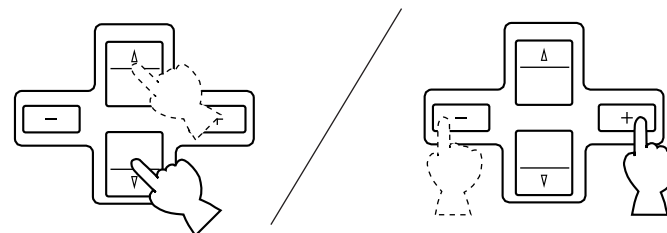

DESCRIPTIONS OF THE SOUND FIELD PROGRAMS

The following list gives brief descriptions of the sound fields produced by each of the DSP programs. Keep in mind that most of these are precise digital recreations of actual acoustic environments. The data for them was recorded at the locations described using sophisticated sound field measurement equipment.

*** The channel level balance between the left rear effect speaker and the right rear effect speaker may vary depending on the sound field you are listening to. This is due to the fact that most of these sound field recreations are actual acoustic environments.**

1. CONCERT HALL 1

Hall A in Europe: This is a large fan-shaped concert hall in Munich which has approximately 2500 seats. Almost the whole interior is made of wood. There is relatively little reflection from the right and left walls, and sounds spread finely and beautifully.

Hall B in Europe: This is a large shoe-box type concert hall with approximately 2500 seats. Almost the whole interior except the ceiling is made of wood, including mahogany reflective panels. Special reflective paneling above the stage produces strong frontal reflections which tend to reinforce the direct sound from the stage. This hall has a very solid, powerful sound.

2. CONCERT HALL 2

Hall C in Europe: A classic shoe-box type concert hall with approximately 1700 seats. Pillars and ornate carvings create extremely complex reflections. Those reflections and the reflections from all directions of the hall produce a very full, rich sound.

Hall D in U.S.A.: This is a large 2600-seat concert hall in the United States which features a fairly traditional European design. The interior is relatively simple, suggesting an American taste. Sound of the middle and high frequencies are richly and beautifully reproduced.

3. CONCERT HALL 3

Hall E in Europe: A classic large shoe-box type concert hall with approximately 2200 seats. It has a circular stage and seats located behind the stage.

Live Concert: A large round concert hall with a rich surround effect. Pronounced reflections from all directions emphasize the extension of sounds. You will experience the sound field with a great deal of presence sitting at about the center position near the stage. This sound field is also effective for karaoke. This is because you feel as if you are standing on a real stage.

4. CHURCH

Tokyo: The acoustic environment of an ordinary church with moderate reverberations. This is ideal for reproducing church music played by a pipe organ etc.

Freiburg: This program recreates the acoustic environment of a big church with a high pointed dome and columns along the sides. This interior produces very long reverberations.

5. ROCK CONCERT

The Roxy Theatre: The ideal program for lively, dynamic rock music. The data for this program was recorded at LA's "hottest" rock club.

Warehouse Loft: This program simulates a space enclosed by concrete. An energetic sound field is created with relatively clear reflections by the wall.

6. JAZZ CLUB

Village Gate: A jazz club in New York. It is in a basement and has a relatively spacious floor area. The reflection pattern is similar to that of a small hall.

Cellar Club: This is a small, cozy jazz club with a low ceiling. The sound is very close and intimate.

7. CONCERT VIDEO 1

Classical/Opera: This program provides excellent depth of vocals and overall clarity, restraining excessive reverberation. For opera, the orchestra pit and the stage are ideally combined, letting you feel a full presence sound. The rear surround side of the sound field is relatively moderated, however, it reproduces beautiful sound by the use of the data of a concert hall. You will not be tired from long watching of an opera.

Recital: This program creates a widely surrounded-by-sound environment. Vocals are reproduced clearly on the stage with good stage depth. Moderate reverberations let you feel the presence of the hall. This program is ideal for bringing together music and video.

8. CONCERT VIDEO 2

Pop/Rock: This program produces an enthusiastic atmosphere and lets you feel that you are in the midst of the action, as if attending an actual jazz or rock concert. The indirect sound constituent spreads on the surround side of the sound field by the use of data of a large round hall for the surround side, so the image space around the screen and the sound space are fully expanded.

Pavilion: This program reproduces vocals clearly, letting you feel the spaciousness of a pavilion. Reverberation, which is somewhat delayed, reproduces the live sound field unique to a pavilion, and helps to make a concert scene more exciting.

9. TV THEATER

Mono Movie: This program is for reproducing monaural video sources (old movies etc.). Monaural sounds are reproduced with much presence by the front presence side of the sound field and optimum reverberation effect. The use of the center speaker makes conversations more audible, obtaining a pleasant mix of conversations and picture.

Variety/Sports: Though the front presence side of the sound field is relatively narrow, the rear surround side employs the sound environment of a large concert hall. With this program, you can enjoy watching various TV programs such as the news, variety shows, music programs or sports programs. In a stereo broadcast of a sports game, the commentator is oriented at the center position, and the shouts and the atmosphere in the stadium spreads on the surround side, however, spreading of them to the rear side is properly restrained.

10. MOVIE THEATER 1

Ideal for reproducing video discs, video tapes and similar sources which are Dolby Surround encoded and bear the "DOLBY SURROUND" logo.

70 mm Spectacle
(When the Dolby Pro Logic Surround is decoded):

AC-3 Spectacle
(When the Dolby Surround AC-3 is decoded):

This program creates the extremely wide sound field of a 70 mm film movie theater. It precisely reproduces the source sound in detail, giving both the video and the sound field incredible reality. Any kind of Dolby Surround video sources (especially large-scale movie productions) are ideal for use with this program.

70 mm Musical
(When the Dolby Pro Logic Surround is decoded):

AC-3 Musical
(When the Dolby Surround AC-3 is decoded):

The data of the sound field of the newest concert hall that has powerful reverberations is used for the front presence side, and the data of the sound field of a hall that has soft reverberations is used for the rear surround side. Therefore, each instrument can be distinguished clearly, and the depth of sound at the screen and the background reflections are beautifully reproduced.

11. MOVIE THEATER 2

Ideal for reproducing video discs, video tapes and similar sources which are Dolby Surround encoded and bear the "DOLBY SURROUND" logo.

70 mm Adventure

(When the Dolby Pro Logic Surround is decoded):

AC-3 Adventure

(When the Dolby Surround AC-3 is decoded):

This program is ideal for precisely reproducing the sound design of the newest 70 mm/AC-3 multi-track films. The sound field is made to be similar to that of the newest movie theaters, so the reverberations of the sound field itself are restrained as much as possible. The data of the sound field of an opera house is used for the front presence side, so the three dimensional feeling of the sound field is emphasized, and dialog is precisely oriented on the screen. By using the data of the sound field of a concert hall on the rear surround side, powerfull reverberations are generated. You can enjoy watching Sci-Fi, adventure movies, etc. with much presence.

70 mm General

(When the Dolby Pro Logic Surround is decoded):

AC-3 General

(When the Dolby Surround AC-3 is decoded):

This program is for reproducing sounds on a 70 mm/AC-3 multi-track film, and characterized by a soft and extensive sound field. The front presence side of the sound field is relatively narrow. It spatially spreads all around and toward the screen, restraining echo effect of conversations without losing clarity. For the surround side, the harmony of music or chorus sounds beautifully in a wide space at the rear of the sound field.

12. DOLBY SURROUND

Reproduces video discs, video tapes and similar sources which are Dolby Surround encoded and bear the “DOLBY SURROUND” logo.

PROLOGIC/Normal
(When the Dolby Pro Logic Surround is decoded):

AC-3/Normal
(When the Dolby Surround AC-3 is decoded):

The built-in Dolby Pro Logic Surround decoder or Dolby Surround AC-3 decoder precisely reproduces sounds and sound effects of a source encoded with Dolby Surround. The realization of a highly efficient decoding process improves crosstalk and channel separation and makes sound positioning smoother and more precise.

PROLOGIC/Enhanced
(When the Dolby Pro Logic Surround is decoded):

AC-3/Enhanced
(When the Dolby Surround AC-3 is decoded):

This program ideally simulates the multi-surround speaker systems of the 35 mm film theater. The Dolby Surround decoding and the digital sound field processing is precisely performed without altering the originally designed sound orientation. The surround effects produced by this sound field folds the viewer naturally from the rear to the left and right and toward the screen.

NOTE: The Dolby Surround system is designed to be used with program material (mainly videotaped movie soundtracks) encoded with the Dolby Surround.

NOTE: If the main and center channel sound is considerably altered by overadjustment of the BASS or TREBLE controls, the relationship with the rear channels may produce an unnatural effect.

CREATING YOUR OWN SOUND FIELDS

SELECTING AND EDITING PROGRAM PARAMETERS

WHAT IS A SOUND FIELD?

In order to explain the impressive functions of the DSP system, we need to first understand what a sound field really is.

What really creates the rich, full tones of a live instrument are the multiple reflections from the walls of the room. In addition to making the sound “live”, these reflections enable us to tell where the player is situated, and the size and shape of the room in which we are sitting. We can even tell whether it is highly reflective, with steel and glass surfaces, or more absorbent—wood panels, carpeting and curtains.

THE ELEMENTS OF A SOUND FIELD

In any environment, in addition to the direct sound coming straight to our ears from the player’s instrument, there are two distinct types of sound reflections that combine to make up the sound field:

(1) Early Reflections. Reflected sounds reach our ears extremely rapidly (50 ms — 100 ms after the direct sound), after reflecting from one surface only—for example, from the ceiling or a wall. These reflections fall into specific patterns as shown in the diagram on page 60 for any particular environment, and provide vital information to our ears. Early reflections actually add clarity to the direct sound.

(2) Reverberations. These are caused by reflections from more than one surface—walls, ceiling, the back of the room—so numerous that they merge together to form a continuous sonic “afterglow”. They are non-directional, and lessen the clarity of the direct sound.

Direct sound, early reflections and subsequent reverberation taken together help us to determine the subjective size and shape of the room, and it is this information that the DSP system reproduces in order to create sound fields.

If you could create the appropriate early reflections and subsequent reverberations in your listening room, you would be able to create your own listening environment. The acoustics in your room could be changed to those of a concert hall, a dance floor, or virtually any size room at all. This ability to create sound fields at will is exactly what Yamaha has done with the DSP system.

DSP programs consist of some parameters to determine apparent room size, reverberation time, distance from you to the performer, etc. In each program, those parameters are preset with values precisely calculated by Yamaha to create the sound field unique for the program. It is recommended to use DSP programs without changing values of parameters, however, this unit also allows you to create your own sound fields. Starting with one of the built-in programs, you can adjust those parameters. Even if power is turned off, your custom sound fields will remain in the DSP system’s memory for about two weeks. The following pages detail how to make your own sound fields.

In addition to the “TYPE” parameter which selects the sub-programs within each sound field program (e.g. “Hall A in Europe” and “Hall B in Europe” for program 1, “CONCERT HALL 1”), each program also has a set of parameters that allow you to change the characteristics of the acoustic environment to create precisely the effect you want. These parameters correspond to the many natural acoustic factors that create the sound field you experience in an actual concert hall or other listening environment. The size of the room, for example, affects the length of time between the “early reflections”—that is, the first few widely spaced reflections you hear after the direct sound. The “ROOM SIZE” parameter provided in many of the DSP programs alters the timing between these reflections, thus changing the shape of the “room” you hear. In addition to room size, the shape of the room and the characteristics of its surfaces have a significant effect on the final sound. Surfaces that absorb sound, for example, cause the reflections and reverberations to die out quicker, while highly reflective surfaces allow the reflections to carry on for a longer period of time. The DSP parameters allow you to control these and many other factors that contribute to your personal sound field, allowing you to essentially “redesign” the concert halls and rooms provided to create custom-tailored listening environments that ideally match your mood and music.

Refer to “DESCRIPTIONS OF THE DIGITAL SOUND FIELD PARAMETERS” on page 60 for a description of what each parameter does, how it effects the sound, and its control range.

1. With the desired program selected, press the Parameter Select (∇) key on the remote control unit once. This will recall the next parameter after the program type. In the case of the CONCERT HALL 1 program, for example, this would be the INIT. DLY parameter. You can continue pressing the Parameter Select (∇) key to select other parameters in sequence. Press the Parameter Select (Δ) key to scroll upward through the parameter list.

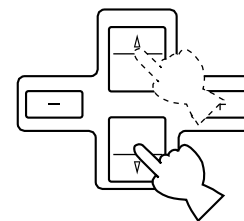

2. When the desired parameter has been recalled, use the Parameter + (increment) and – (decrement) keys to change its value to create the effect you want. + increases the value of the selected parameter, and – decreases the value of the selected parameter. In both cases you can hold the key down for continuous incrementing or decrementing. The display will pause for a moment at the initial value of the parameter as a reminder. (On the monitor screen, * mark at the head of parameter name disappears at the initial value of the parameter.)

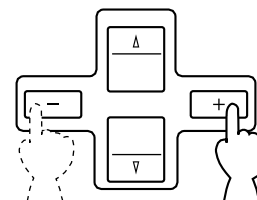

NOTE: Parameter edits made in this way will remain in effect even with power cut due to power failure or the power plug disconnected from the AC outlet for up to about two weeks, after which all parameters, as well as other adjustments or setting changes on this unit, will return to their initial values or conditions.

DESCRIPTIONS OF THE DIGITAL SOUND FIELD PARAMETERS

Not all of the following parameters are found in every program.

● ROOM SIZE

How it Affects the Sound:

Changes the apparent size of the music venue. The larger the value, the larger the simulated room will sound.

What it Does:

Adjusts the timing between the early reflections. Early reflections are the first group of reflections you hear before the subsequent, dense reverberation begins.

Control Range:

0.1 – 2.0

Standard setting is 1.0.

Changing this parameter from 1 to 2 increases the apparent volume of the room eight times (length, width, and height all doubled).

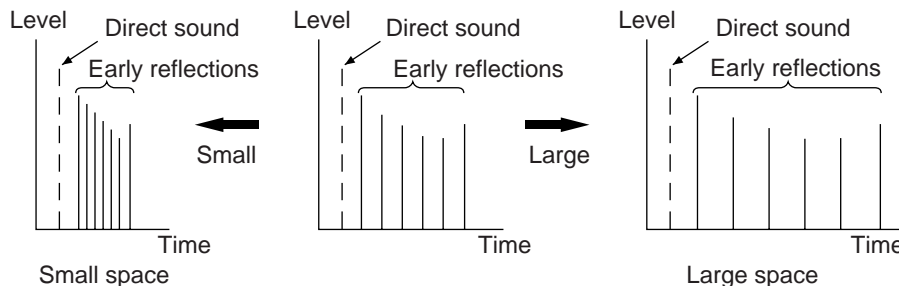

● INIT. DLY (Initial Delay)

How it Affects the Sound:

Changes the apparent distance from the source sound.

Since the distance between a sound source and a reflective surface determines the delay between the direct sound and the first reflection, this parameter changes the location of the sound source within the acoustic environment.

What it Does:

Adjusts the delay between the direct sound and the first reflection heard by the listener.

Control Range:

1 – 99 milliseconds

For a small living room this parameter would be set for a small value. Large values for a big room. Larger values produce an echo effect.

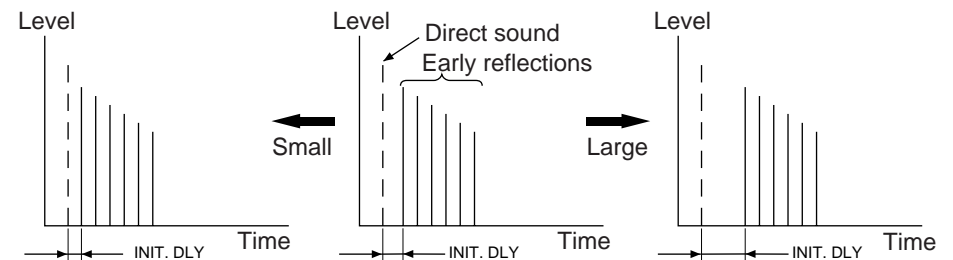

● LIVENESS

How it Affects the Sound:

This parameter changes the apparent reflectivity of the walls in the hall.

The early reflections from a sound source will lose intensity (decay) much faster in a room with acoustically absorbent wall surfaces than in one which has mostly reflective surfaces. A room with highly reflective surfaces in which the early reflections decay slowly is termed “live”, while a room with absorbent characteristics in which the reflections decay rapidly is termed “dead”. The LIVENESS parameter lets you adjust the early reflection decay rate, and thus the “liveness” of the room.

What it Does:

Changes the rate at which the early reflections decay.

Control Range:

0 – 10.

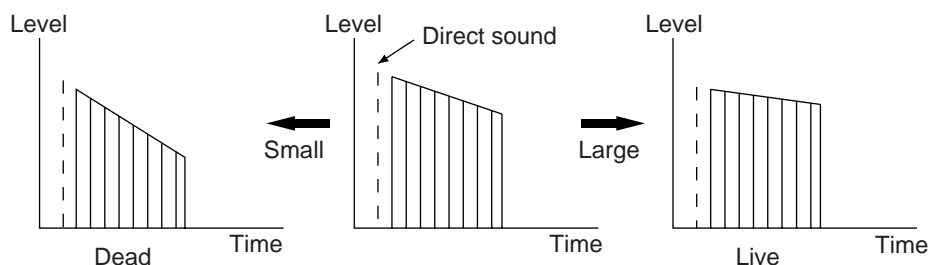

● REV. TIME (Reverberation Time)

How it Affects the Sound:

The natural reverberation time of a room depends primarily on its size and the characteristics of its inner surfaces. This parameter, therefore, changes the apparent size of the acoustic environment over an extremely wide range.

What it Does:

Adjusts the amount of time it takes for the level of the dense, subsequent reverberation sound to decay by 60 dB (@ 1 kHz).

Control Range:

1.0 – 5.0 seconds.

The reverb time in a small-to-medium size hall would be between 1 and 2, and in a large hall it is normally between 2 and 3.

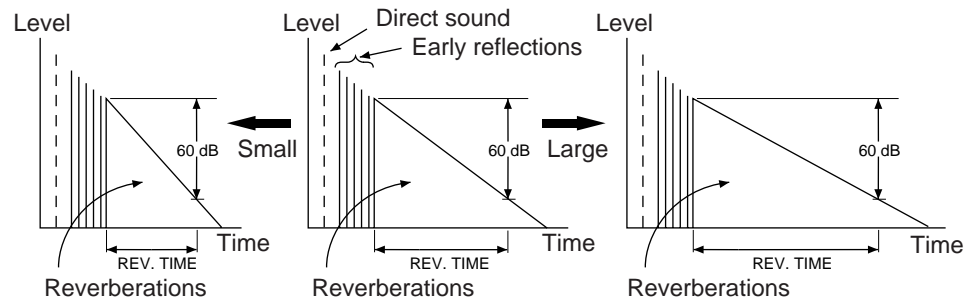

- **REV. DELAY (Reverberation Delay)**

This parameter sets the time difference between the beginning of the direct sound and the beginning of the reverberation sound. The larger the value, the later the reverberation sound will begin. A later reverberation sound makes you feel like the space of the acoustic environment has become larger.

Control Range:

0 – 250 milliseconds

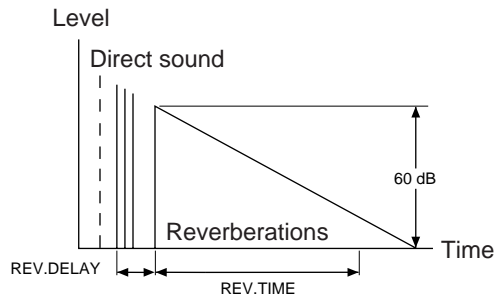

- **REV. LEVEL (Reverberation Level)**

This parameter adjusts the volume of the reverberation sound. The larger the value, the stronger the reverberation becomes.

Control Range:

0 – 100%

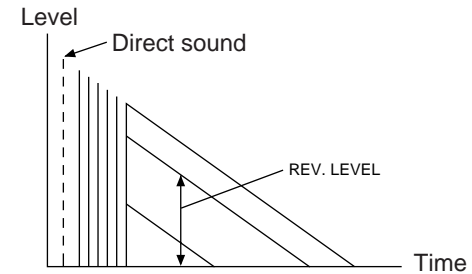

- **EFCT TRIM (Effect Trim)**

Performs fine adjustment of the level of all the effect sounds.

Control Range:

-3 dB to 3 dB

- **P. INIT. DLY (Presence Initial Delay)**

Adjusts the delay between the direct sound and the first reflection on the presence side of the sound field. The larger the value, the later the first reflection begins.

Control Range:

1 – 49 milliseconds

- **P. ROOM SIZE (Presence Room Size)**

Adjusts the apparent space size of the front presence sound field. The larger the value, the longer the interval between reflections becomes, which increases the depth of the sound source.

Control Range:

0.1 – 2.0

- **S. INIT. DLY (Surround Initial Delay)**

Adjusts the delay between the direct sound and the first reflection on the rear surround side of the sound field. The larger the value, the later the first reflection begins.

- * This parameter is available only when an AC-3 RF signal or digital AC-3 input signal is input to this unit. When another signal is input, the value of this parameter is shown by “_ _”.

Control Range:

1 – 49 milliseconds

- **S. DELAY (Surround Delay)**

Adjusts the delay between the direct sound and the first reflection on the rear surround side sound field. The larger the value, the later the surround sound field is generated.

- * This parameter is available only when an AC-3 RF signal or digital AC-3 input signal is input to this unit. When another signal is input, the value of this parameter is shown by “_ _”.

Control Range:

When the Dolby Pro Logic Surround is decoded:

15 – 30 milliseconds

When the Dolby Surround AC-3 is decoded:

0 – 15 milliseconds

When a program without Dolby Surround decoding is used:

1 – 49 milliseconds

- **S. ROOM SIZE (Surround Room Size)**

Adjusts the apparent space size of the rear surround sound field. The larger the value, the larger the surround sound field becomes.

Control Range:

0.1 – 2.0

- **S. LIVENESS (Surround Liveness)**

Adjusts the apparent reflectivity of the walls on the rear surround sound field. The larger the value, the more reflective the surround sound field becomes.

Control Range:

0 – 10

REMOTE CONTROL LEARNING FUNCTION

The remote control unit, in addition to controlling the most commonly used functions of the main unit and other connected Yamaha audio and video equipment, has a sophisticated “learning” function that allows it to control other equipment in your system or other household appliances equipped with infrared remote control receivers. By setting the YPC/USER/LEARN switch on the remote control unit to “LEARN”, all keys will turn into “learnable function keys”, each capable of “learning” a different remote control function. Also, each key can learn two different functions by switching the learning group (1 or 2) with the 1/2 switch. However, as for the keys shaded in the following figure, the PARAMETER/SET MENU switch will select the learning group number (1 or 2) instead of the 1/2 switch.

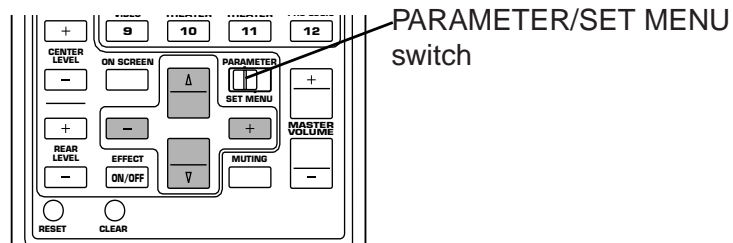

Learning a New Remote Control Function

1. Select the learning group number (1 or 2) by using the 1/2 switch.
2. Set the YPC/USER/LEARN switch to “LEARN”.
3. Aim the infrared transmitter window of the other remote control unit.

4. Press the key that is to have a new function assigned to it. The TRANSMIT/LEARN indicator will light up.
5. Press and hold down the button on the other remote control unit corresponding to the new function to be learned. Hold the button down until the TRANSMIT/LEARN indicator is extinguished. The function has now been learned.

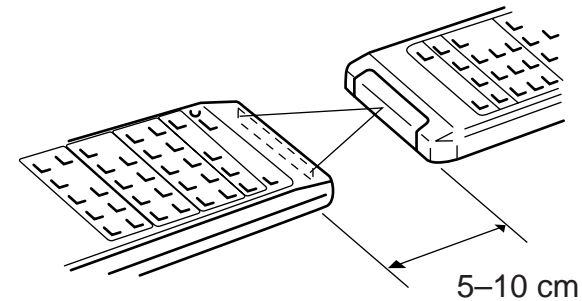

6. Repeat steps 4 and 5 to learn additional functions.
7. Set the YPC/USER/LEARN switch to “USER”. Pressing the learned key will now perform the assigned function. Provided user program sheets should be used to record the functions learned by the various keys.

NOTE: The originally preset function of a key is still available in the USER position if the key does not learn a new function.

NOTE: If there is no more room in the memory area for a function to be learned, the TRANSMIT/LEARN indicator will flash on and off eight times. In this case, even if some keys are not occupied with functions from other remote control units, no further learning is possible.

The function learned by any key can be easily changed by repeating the learning process with a different function. It is also possible to erase learned functions so that the keys return to the originally preset functions.

Erasing a Learned Function

1. Set the YPC/USER/LEARN switch to “USER”.
2. Use the point of a pencil or other similar object to press and hold the CLEAR button.
3. Press and hold the key whose function is to be erased until the TRANSMIT/LEARN indicator flashes on and off three times.

Erasing All Learned Functions

1. Set the YPC/USER/LEARN switch to “LEARN”.
2. Use the point of a pencil or other similar object to press and hold the CLEAR button.
3. Press and hold any key until the TRANSMIT/LEARN indicator flashes on and off seven times.

NOTE: All of the memorized functions will be retained while you replace the batteries. However, if no batteries are installed for a few hours, the memory will be erased and will have to be programmed again.

NOTE: There may occasionally be instances in which, due to the signal-coding and modulation systems employed by another remote control unit, that this remote control unit will not be able to learn its signals. In this case, the TRANSMIT/LEARN indicator will flash on and off eight times.

NOTE: When the remote control freezes, press the RESET button to “reset” the internal microcomputer which controls remote control operations. Pressing the RESET button will not erase learned functions.

TROUBLESHOOTING

PROBLEM	POSSIBLE CAUSE	WHAT TO DO
Power does not come on.	AC cord not properly plugged in.	Carefully plug AC plug into outlet.
Hum.	Bad cable connection.	Firmly plug in all connection cables.
No sound.	Bad or incorrect input connection. Incorrect input source selection.	Check connections. Select the appropriate input source with the INPUT SELECTOR or the TAPE 2 MONITOR switch.
No sound from the effect speakers.	The EFFECT switch is set off. A Dolby Surround decoding program is being used with material not encoded with Dolby Surround.	Press the EFFECT switch to turn it on. Use a different sound field program.
No sound from the front effect speakers.	The FRONT MIX switch is set to "ON". PROLOGIC/Normal (or AC-3/Normal) of the sound field program No. 12 is selected.	Set the FRONT MIX switch to "OFF". Select another program (or sub-program).
No sound from the center speaker.	The CENTER SPEAKERS mode is in "PHNTM". One of the sound field programs No. 1 to No. 6 is selected.	Select the appropriate mode. Select another program.
Poor bass reproduction.	The LFE/BASS OUT mode is in the SW or BOTH position, through your system does not include a subwoofer. Output mode selection for each channel (MAIN, CENTER or REAR) is improper.	Select the MAIN position. Make output mode selections suitable for your speaker system.
The sound suddenly goes off.	The protection circuit has activated because of short circuit etc.	Turning the unit off and then on will reset the protection circuit.
The volume level cannot be increased, or sound is distorted.	The power to the component connected to the REC OUT jacks of this unit is off.	Turn the power to the component on.
DSP parameters and some other settings on this unit cannot be changed.	The "MEMORY GUARD" function is set ON.	Turn the "MEMORY GUARD" OFF.
The sound field cannot be recorded.	It is not possible to record the sound field on a tape deck connected to this unit's TAPE REC OUT jacks.	
This unit will not operate properly.	The internal microcomputer has been frozen by an external electric shock (lightning, excessive static electricity, etc.) or power supply with low voltage.	Unplug the AC power cord from the wall AC outlet, and then plug in again after about one minute.
A source cannot be recorded by a tape deck or VCR connected to this unit.	The source unit is connected to this unit between digital jacks only.	Make additional connection between analog jacks.
Noise from nearby TV or tuner.	This unit is too close to the affected equipment.	Move the unit further away from the affected equipment.

PROBLEM	POSSIBLE CAUSE	WHAT TO DO
The sound is degraded when listening with the headphones connected to the compact disc player or cassette deck that are connected with this unit.	The power to this unit is off.	Turn the power to this unit on.
The remote control unit does not function properly.	Dead batteries. Wrong distance or angle. Direct sunlight or lighting (of an inverter type of fluorescent lamp etc.) is striking the remotecontrol sensor of the main unit. The internal microcomputer "freezes".	Replace batteries. The remote control unit will function from a maximum range of 6 meters, no more than 30 degrees off-axis from the front panel. Change position of the main unit. Press the RESET button on the remote control unit.
The remote control unit cannot learn a new function from another remote control unit.	Memory is full. There may occasionally be instances in which, due to the signal-coding and modulation systems employed by another remote control unit, that this remote control unit will not be able to learn its signals.	Erase unnecessary functions.
Continuous functions such as volume are learned, but operate only for a moment before stopping.	Learning process incomplete.	Be sure to press and hold the function key on the other remote control until the TRANSMIT/LEARN indicator is extinguished.

SPECIFICATIONS

Minimum RMS Output Power Per Channel

Main (20 Hz – 20 kHz 0.015% THD 8Ω)	80W+80W
Center (20 Hz – 20 kHz 0.015% THD 8Ω)	80W
Front Effect (1 kHz 0.05% THD 8Ω).....	.25W+25W
Rear Effect (20 Hz – 20 kHz 0.015% THD 8Ω)	80W+80W

Dynamic Power Per Channel

(by IHF Dynamic Headroom Measuring Method)

[U.S.A., Canada and General models]	
MAIN L/R (8Ω/6Ω/4Ω)	100W/120W/160W

Dynamic Headroom [U.S.A., Canada and General models]

MAIN L/R (8Ω)	0.97 dB
---------------------	---------

DIN Standard Output Power Per Channel [Europe and U.K. models]

MAIN L/R (1 kHz 0.7% THD 4Ω)	130W
------------------------------------	------

IEC Power [Europe and U.K. models]

MAIN L/R (1 kHz 0.015% THD 8Ω)	85W
--------------------------------------	-----

Damping Factor

MAIN L/R, CENTER (20 Hz – 20 kHz 8Ω)	200
--	-----

Input Sensitivity/Impedance (100W/8Ω)

CD/TUNER/TAPE/LD/TV-DBS/VCR/VIDEO AUX.....	150 mV/47 kΩ
PHONO MM.....	2.5 mV/47 kΩ
MAIN IN.....	1V/47 kΩ

Maximum Input Signal (1 kHz 0.05% THD, EFFECT ON)

CD/TUNER/TAPE/LD/TV-DBS/VCR/VIDEO AUX	2.3V
PHONO MM	130 mV

Output Level/Impedance

REC OUT	150 mV/1 kΩ
PRE OUT	
MAIN, CENTER, REAR EFFECT, FRONT EFFECT.....	1V/1.2 kΩ
SUBWOOFER (SPLIT L, R) (MAIN SPEAKERS: SMALL)	2.0V/1.2 kΩ
SUBWOOFER (MONO) (MAIN SPEAKERS: SMALL)	3.4V/1.2 kΩ

Maximum Voltage Output (20 Hz – 20 kHz, 1% THD)

PRE OUT (MAIN L/R).....	3V
-------------------------	----

Headphone Jack Rated Output/Impedance

Output Level (CD Input 50 mV, RL=8Ω).....	0.2V
Impedance	100Ω

Frequency Response (20 Hz – 20 kHz)

CD/TUNER/TAPE/LD/TV-DBS/VCR/VIDEO AUX to MAIN L/R SP OUT	
.....	0±0.5 dB

RIAA Equalization Deviation (20 Hz – 20 kHz)

PHONO MM	0±0.5 dB
----------------	----------

Total Harmonic Distortion (20 Hz – 20 kHz)

CD/TUNER/TAPE/LD/TV-DBS/VCR/VIDEO AUX to PRE OUT (MAIN L/R), 1V	
.....	0.005%
PHONO MM to REC OUT, 3V	0.01%
MAIN IN to SP OUT (MAIN L/R, CENTER), 40W/8Ω.....	0.005%

Signal-to-Noise Ratio (IHF-A Network)

CD/TUNER/TAPE/LD/TV-DBS/VCR/VIDEO AUX (Input Shorted 150 mV)	
(EFFECT OFF)	More than 96 dB
PHONO MM (Input Shorted 5 mV) (EFFECT OFF)	More than 86 dB

Residual Noise (IHF-A Network)

MAIN L/R SP OUT.....	150 μV
----------------------	--------

Channel Separation (Vol –30 dB)

CD/TUNER/TAPE/LD/TV-DBS/VCR/VIDEO AUX Input 5.1 kΩ Shorted	
(EFFECT OFF) 1 kHz/10 kHz	More than 70 dB/60 dB
PHONO MM Input Shorted (EFFECT OFF)	
1 kHz/10 kHz.....	More than 70 dB/60 dB

Tone Control Characteristics

Bass	
Boost/Cut	±10 dB (50 Hz)
Turnover frequency	350 Hz
Treble	
Boost/Cut	±10 dB (20 kHz)
Turnover frequency	3.5 kHz

BASS EXTENSION (MAIN L/R) +6 dB (70 Hz)

Filter Characteristics (Highcut Filter)

SUBWOOFER (fc = 90 Hz) 24 dB/oct.

Audio muting -20 dB

Video Section

Video Signal Type	
[U.S.A. and Canada Models].....	NTSC
[Europe, U.K. and Australia models]	PAL
[General Model]	NTSC/PAL
Video Signal Level	1 Vp-p/75Ω
S-Video Signal Level	
Y	1 Vp-p/75Ω
C	0.286 Vp-p/75Ω
Maximum Input Level	More than 1.5 Vp-p
Signal-to-Noise Ratio	50 dB
Monitor Out Frequency Response	5 Hz – 10 MHz, -3 dB

Power Supply

U.S.A. and Canada models	AC 120V/60 Hz
Europe and U.K. models	AC 230V/50 Hz
Australia model	AC 240V/50 Hz
General model	AC 110/120/220/240V 60/50 Hz

Power Consumption

U.S.A. and Canada Models	450W/600 VA
Europe, U.K., Australia and General models.....	400W

AC Outlets

2 SWITCHED OUTLETS	
[U.S.A. model]	120W max. total
[Canada and General models]	100W max. total
1 SWITCHED OUTLET	
[Europe, U.K. and Australia models]	100W max.
1 UNSWITCHED OUTLET	
[U.S.A. and Canada models]	180W max.
[General model]	200W max.

Dimensions (W x H x D) 435 x 170 x 476.5 mm
(17-1/8" x 6-11/16" x 18-3/4")

Weight 21.0 kg (46 lbs. 3 oz.)

* Specifications are subject to change without notice.

YAMAHA

YAMAHA CORPORATION

YAMAHA ELECTRONICS CORPORATION, USA 6660 ORANGETHORPE AVE., BUENA PARK, CALIF. 90620, U.S.A.
YAMAHA CANADA MUSIC LTD. 135 MILNER AVE., SCARBOROUGH, ONTARIO M1S 3R1, CANADA
YAMAHA ELECTRONIK EUROPA G.m.b.H. SIEMENSSTR. 22-34, 25462 RELLINGEN BEI HAMBURG, F.R. OF GERMANY
YAMAHA ELECTRONIQUE FRANCE S.A. RUE AMBROISE CROIZAT BP70 CROISSY-BEAUBOURG 77312 MARNE-LA-VALLEE CEDEX02, FRANCE
YAMAHA ELECTRONICS (UK) LTD. YAMAHA HOUSE, 200 RICKMANSWORTH ROAD WATFORD, HERTS WD1 7JS, ENGLAND
YAMAHA SCANDINAVIA A.B. J A WETTERGRENS GATA 1, BOX 30053, 400 43 VÄSTRA FRÖLUNDA, SWEDEN
YAMAHA MUSIC AUSTRALIA PTY, LTD. 17-33 MARKET ST., SOUTH MELBOURNE, 3205 VIC., AUSTRALIA

VU 18150

YAMAHA

DSP-A3090

GUIDE TO SYSTEM CONNECTION

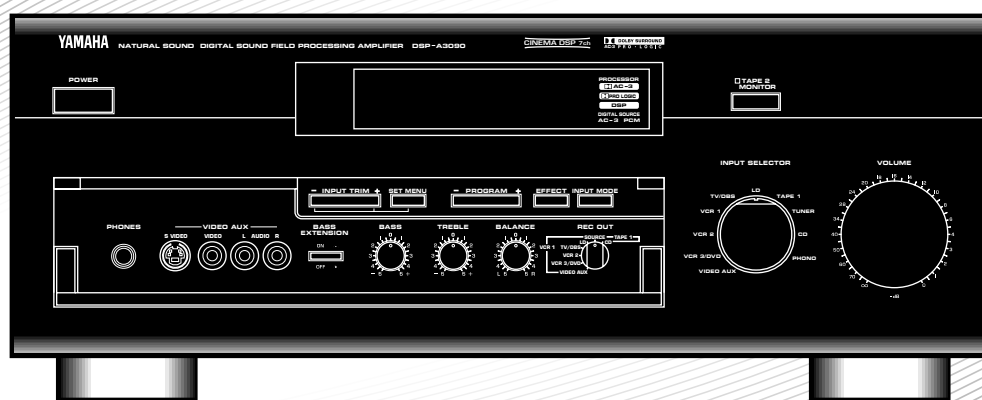

Set Up The Speakers Before Making Connections

Place the **Front Effect Speakers** further apart from the Main Speakers, on either side of and a few feet behind and above the Main Speakers.

If you will use a **Subwoofer** such as a Yamaha Active Servo Subwoofer System, the position of the subwoofer is not so critical because low bass tones are not highly directional.

Place the **Main Speakers** in the normal position.

Place the **Center Speaker** precisely between the two Main Speakers.

Place the **Rear Effect Speakers** behind your listening position. They should be nearly six feet up from the floor.

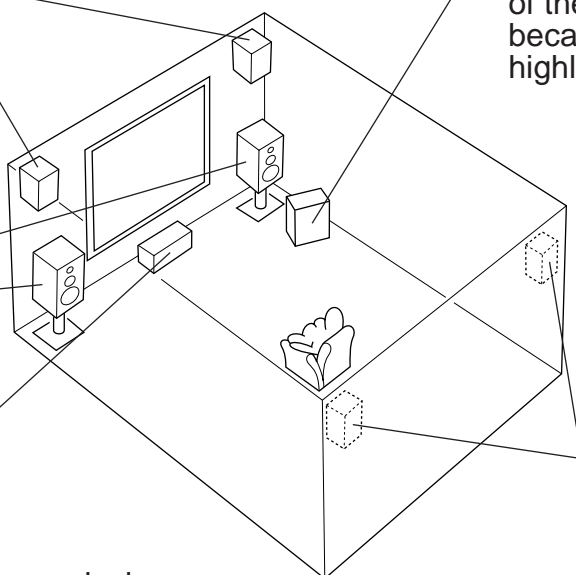

CONNECTING SPEAKERS

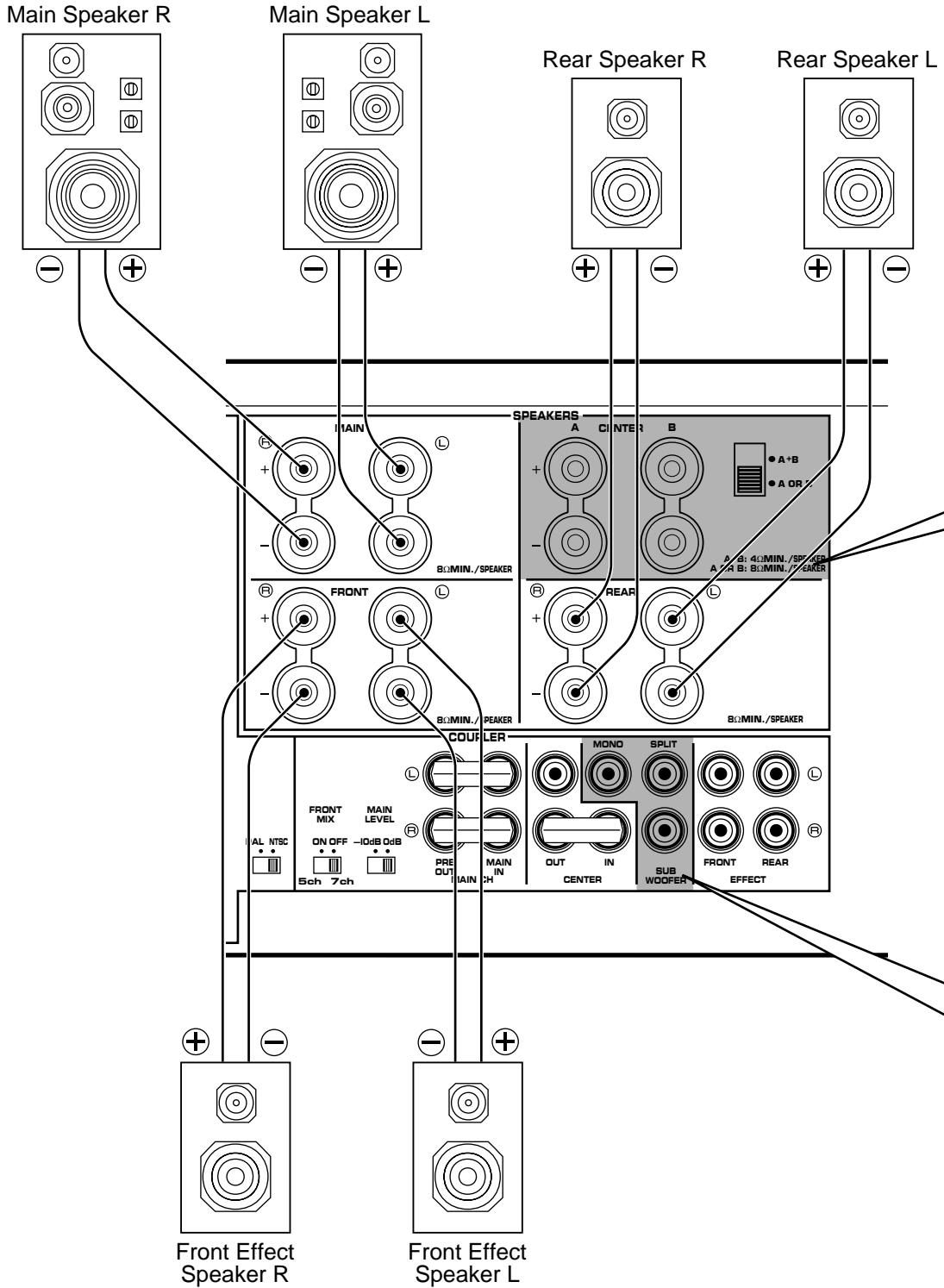

Connect bare ends of speaker wires to terminals or use Banana Plugs

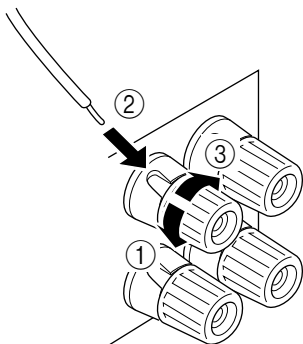

Red: positive (+)
Black: negative (-)

- ① Unscrew the knob.
- ② Insert the bare wire.
- ③ Tighten the knob and secure the wire.

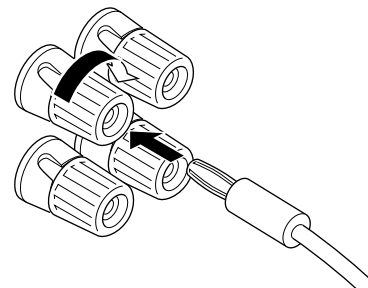

CENTER SPEAKER(S)

To Use One Center Speaker

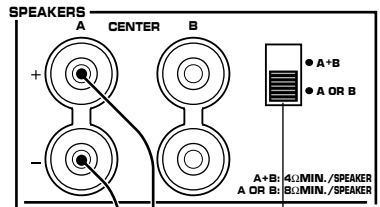

Set to "A OR B".

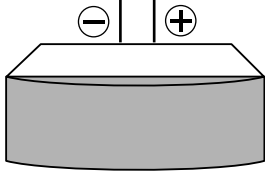

To Use Two Center Speakers

Set to "A + B".

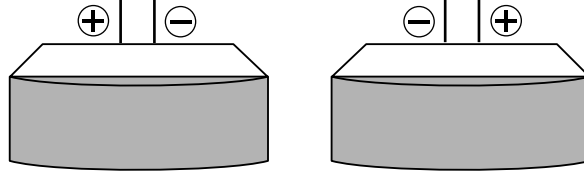
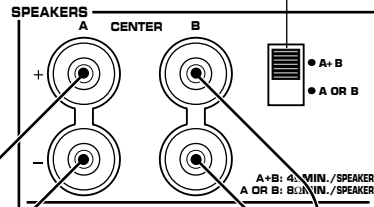

SUBWOOFER

To Use One Subwoofer System

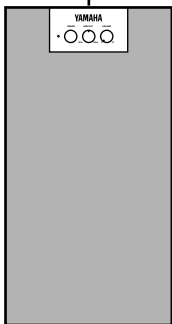
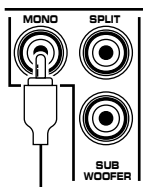

To Use Two Subwoofer Systems

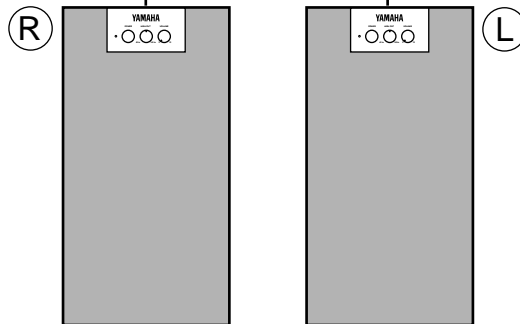
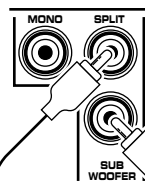

CONNECTING VIDEO COMPONENTS

1 Audio Connections

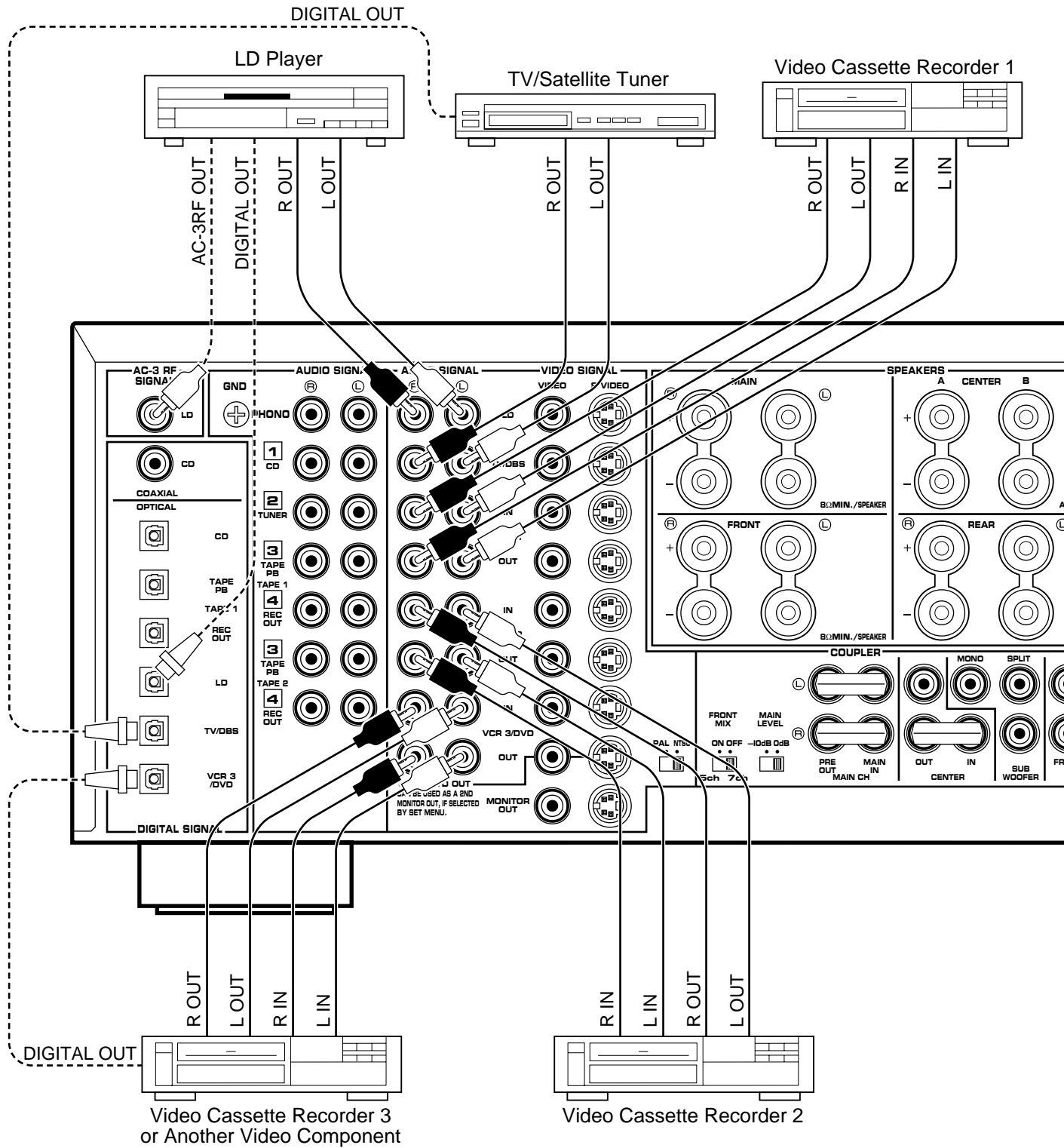





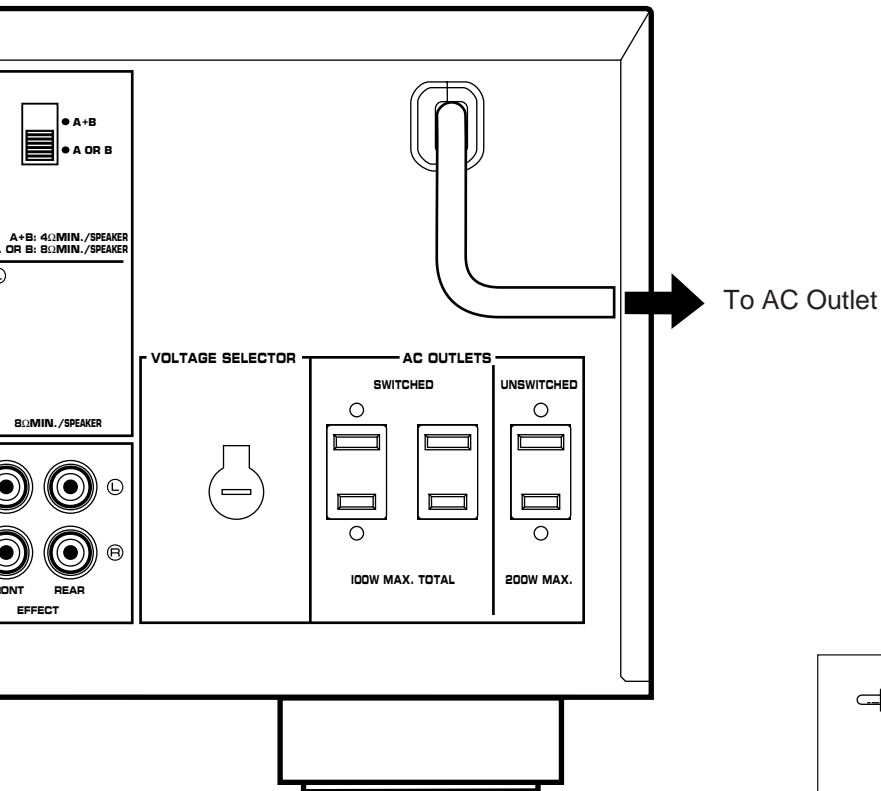

Notes

- If your components are equipped with digital audio signal output (and input) jacks, they can be connected to this unit's DIGITAL SIGNAL input (and output) jacks.
- Even if you connect a component to the DIGITAL SIGNAL jack of this unit, you must keep the component connected with the same named analog audio signal jacks of this unit, because digital signal cannot be recorded by a tape deck or VCR other than the tape deck connected to the OPTICAL TAPE 1 REC OUT jack of this unit.
- If your LD player has an AC-3 RF signal output jack, connect it to this unit's AC-3 RF SIGNAL input jack. Audio signals encoded with the Dolby Surround AC-3 are input to this unit by this connection.

(General Model)



-  : RCA Pin Plug Connector Cable
-  (Red): Right Audio
-  (White): Left Audio
-  : Optical Fiber Cable

-  : Basic Connection (Required)
-  : Additional Connection For Higher Sound Quality Or Special Performance

2 Video Connections

If your video components offer S-Video capability, they can be connected to this unit's S VIDEO jacks. Otherwise, connect the composite video input/output jacks of your video components to this unit's composite VIDEO input/output jacks.

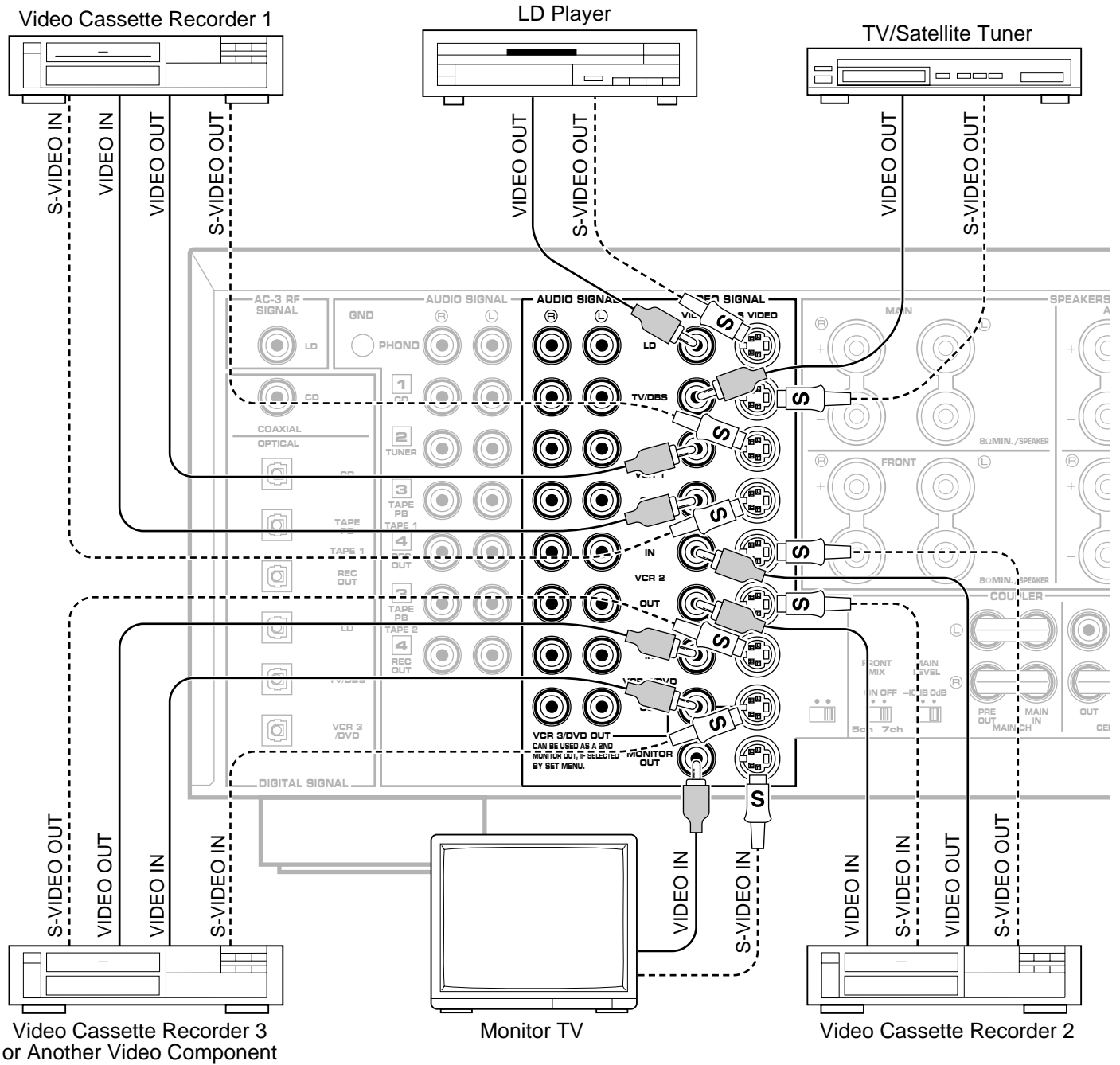

Note

If you wish to connect a second monitor TV (or a projector) to this unit, you can switch the VCR 3/DVD VIDEO OUT jack (and S VIDEO jack also) to a second monitor out jack for the connection with another monitor TV. (See page 43 of the Owner's Manual for details.)

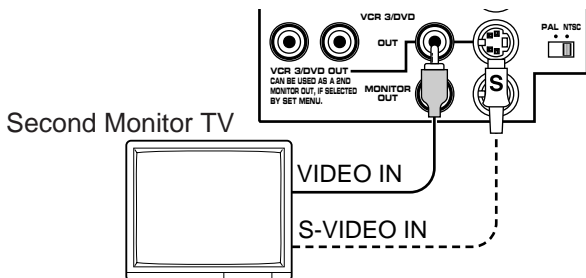
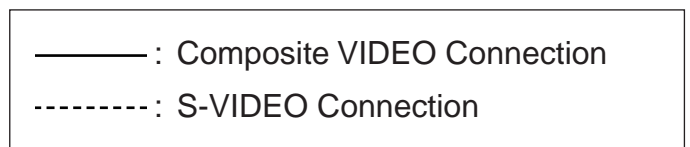
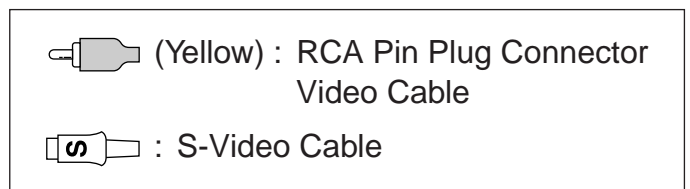

CONNECTING AUDIO COMPONENTS

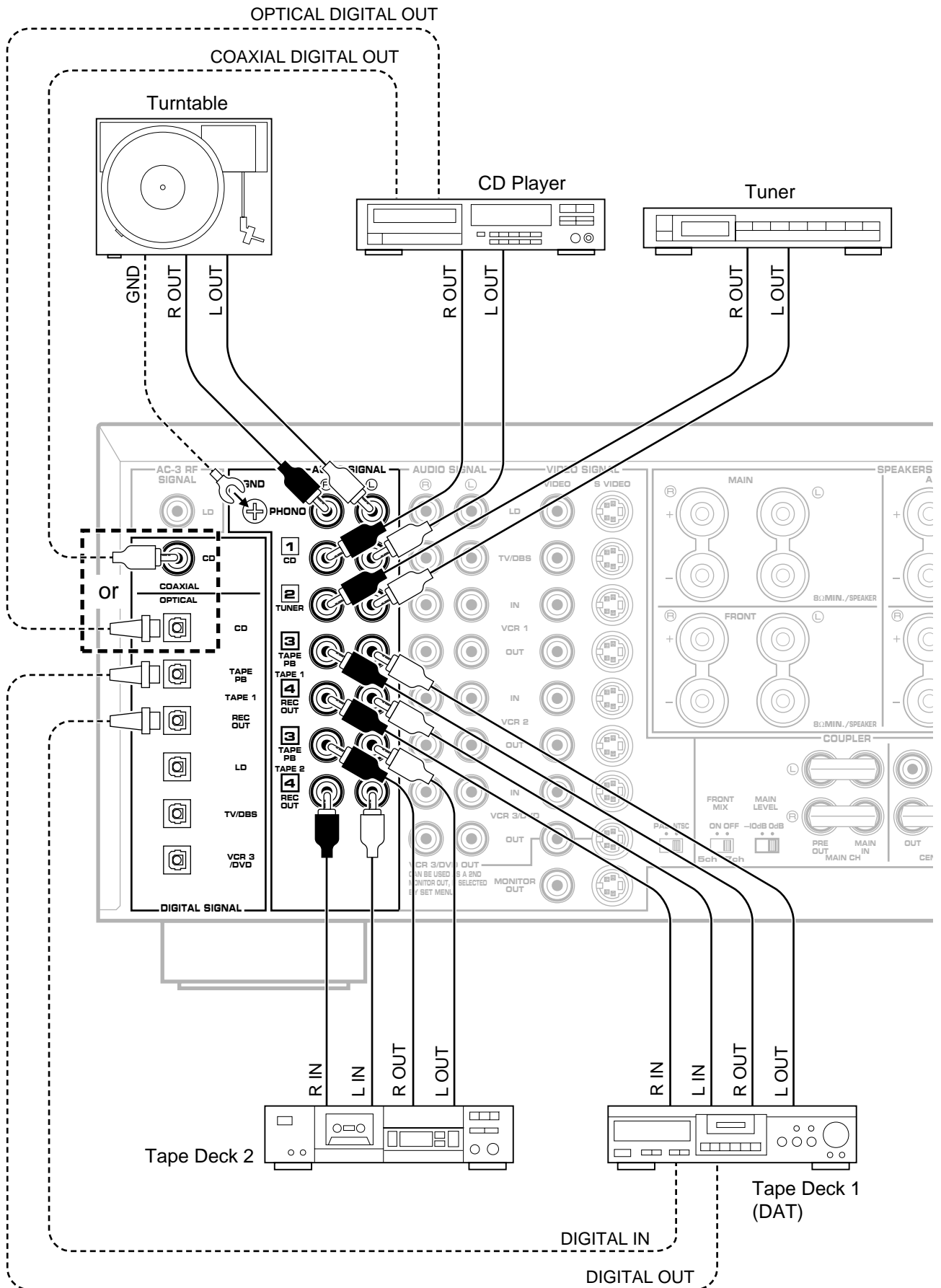

Settings Of Switches On The Rear Panel

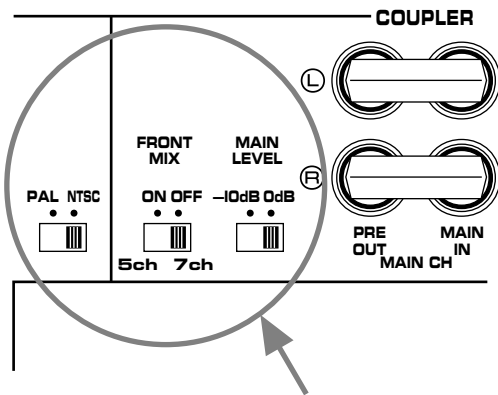

MAIN LEVEL Switch

Normally set to "0 dB". If desired, you can decrease the main-channel output level at the MAIN speaker terminals by 10 dB by setting this switch to "-10 dB".

FRONT MIX Switch

Set to "OFF (7ch)" when setting up a full 7 or 6 speaker system, or to "ON (5ch)" when setting up a 5 or 4 speaker system.

PAL/NTSC Switch (General Model Only)

Set this switch to the position corresponding to the video format that your video equipment employs.

Connecting External Power Amplifier(s)

If you wish to use an external power amplifier to drive speakers for any channel, connect the power amplifier to the corresponding line-level output jacks of this unit.

